

ROBAM



使用说明书

User Manual

使用产品前请仔细阅读本使用说明书，并妥善保管。如果说明书丢失，你可以发送邮件至 overseas@robam.com，获取电子版说明书。

Before operating this unit, please read the user manual completely and keep it. If the manual is lost, you can send e-mail to overseas@robam.com, request for an electronic manual.

CXW-220-A852

吸油烟机
Range Hood

CONTENTS

Safety Precaution.....	1
Important Information.....	4
Product Description.....	5
Packing List.....	5
Installation.....	6
User Manual.....	9
Maintenance.....	10
Removal of Components.....	10
Circuit Diagram.....	12
Troubleshooting of General faults.....	13

Dear users:



Thank for your buying our range hood. Please accept our best regards. Please read this user manual carefully before installation and operation.

*The pictures in this manual only for your reference. If the picture isn't accord with object, subject to object. We keep to right to update appearance, structure or products without notice.

Safety Precaution

In order to avoid harm or property damage to the users or other person, the following distinction and marks are stipulated. They are important safety precaution, please comply strictly based on the full understanding.

Subject to harmful or destruct degree







 Danger	If ignore this sign and operate product improperly, it's highly possible to cause danger, serious injury or fire.
 Warning	If ignore this sign and operate product improperly, it's possible to cause danger, serious injury or fire.
 Notice	If ignore this sign and operate product improperly, it's possible to cause injury or loss.

Notice and Prohibit Mark

 Prohibit	 Prohibit Flame	 Prohibit Touch	 Prohibit Touch by Wet Hand	 Prohibit Disassembly	 Strict Execution	 Necessary Earthed	 Caution Electric Shock	 Caution Scald
---	--	--	--	--	--	--	--	---

 **Warning** Please use this product according to manual strictly, or ROBAM shall not take any responsible caused by improper operation.

Danger

 Prohibit	Don't allow children or weakling to use range hood separately, or it may cause electric shock or other accident.
 Prohibit	Prohibit water on motor, switches or other electric parts; Prohibit wash range hood by water spray. Don't use range hood if wet or it may cause electric leakage or shock.
 Prohibit	Don't change, stretch, bind or press electric wire, or it's possible to cause electric shock or fire because of broken wire.
 Prohibit	Prohibit any change of interior circuit, or it may cause injury or other danger, for example, electric shock or fire.
 Prohibit Touch by Wet Hand	Don't touch plug, electric parts or button by wet hands, or it may cause electric shock.
 Strict Execution	Unplug before cleaning, installing or maintaining, avoiding from electric shock.

Danger



Please turn off range hood immediately if pan got fire (range hood shall aggravate fire if it's working) and extinguish fire by effective action. For example, cover flame by metal cover, turn off gas valve immediately and remove inflammable things.



Any abnormal, please turn off power, take off plug or cut off electric source, and contact service. It's possible to cause electric shock or fire if using range hood under abnormal situation.

Warning



Range hood must be installed, disassembled or maintained by professional person.



Stove fire shall be extinguished timely when it is not used; do not flambe under the range hood and it's prohibited to bake food under range hood directly to prevent range hood from damaging and causing accidents.



Don't touch bulb if it's on or just close in short time, or it may cause scald.



In order to ensure safety, range hood must be installed by specific accessory (especially expansion pipe and wooden screws, or it may cause accidental drop of range hood). The pipe bore and hole must fit tightly during the installation of metal expansion pipe. It is prohibited to make excessively large hole to prevent accidental drop of loosening expansion pipe.



The range hood must be used by specific plug and properly ground it. It's possible to cause electric shock, hot plug or fire because of improper electric wire. Installation must be executed by professional person based on local electrical regulations. Before connect electricity, power must be turned off.



If the supply cord is damaged, it must be replaced by the manufacturer, its service agent or similarly qualified persons in order to avoid a hazard.









All operation must comply with our safety guidelines as well as local safety regulations.





There shall be adequate ventilation of the room when the range hood is used at the same time as appliances burning gas or other fuels.







Warning

 Strict Execution	<p>This appliance just for household use only. And it's not allowed to exhaust dangerous or explosive matter or air. It should be put under dry and ventilation environment without dangerous air.</p>
 Strict Execution	<p>The range hood and electric circuit must be installed by skilled and trained personnel with required qualification. When installation, the related regulation, standard or instruction on fire must be complied. It may cause danger because of improper installation, for example, electric shock, drop or fire accident.</p>
 Strict Execution	<p>The outlet must be connect with outside. In order to ensure safety and fresh air, waste gas should be exhaust to outside. Don't exhaust waste gas to the wall, loft or garage.</p>
 Strict Execution	<p>There is a fire risk if cleaning is not carried out in accordance with the instructions.</p>
 Strict Execution	<p>Keep a good habit to turn off gas hob and gas valve if go outside, sleep or finish operation. Replace or check gas pipe regularly, since gas alarm device can't completely avoid accident caused by gas leakage.</p>
 Strict Execution	<p>This appliance is not intended for use by persons (including children) with reduced physical, sensory or mental capabilities, or lack of experience and knowledge, unless they have been given supervision or instruction concerning use of the appliance by a person responsible for their safety. Children should be supervised to ensure that they do not play with the appliance.</p>
 Strict Execution	<p>The minimum distance between the supporting surface for the cooking vessels on the hob and the lowest part of the range hood. When the range hood is located above a gas appliance, this distance shall be at least 650mm. If the instructions for installation for the gas hob specify a greater distance, this has to be taken into account.</p>

Notice

 Prohibit	<p>The air must not be discharged into a flue that is used for exhausting fumes from appliances burning gas or other fuels, the discharge of air must fulfill the requirements of local regulations.</p>
 Strict Execution	<p>Before removing range hood for installation, clean or maintainance, power must be cut off avoiding from electric shock. When installation, clean or maintainance, protective gloove must be wear avoiding from injury.</p>
 Strict Execution	<p>The temperature for range hood working can't exceed 40°C.</p>

Notice

 Strict Execution	<p>Because the installation is difficult and hood is heavy, the installation shall be executed by professional person based on manual.</p>
 Strict Execution	<p>Don't break electric wire or other invisible equipment when cutting something or drilling holes on ceiling.</p>
 Strict Execution	<p>When range hood is using in well sealed building, it should have air inlet or open door to ensure good ventilation.</p>
 Strict Execution	<p>When the oil exceeds 2/3 or near tick mark in the oil cup, clean it in time. Don't eat waste oil from oil cup.</p>
 Strict Execution	<p>The wall of installing range hood needs enough strength. For hollow walls, the thickness of solid layer of hollow wall must be more than 30mm, but for concrete walls, it can be drill holes directly. The range hood must be fixed on the wall firmly.</p>
 Strict Execution	<p>Accessible parts may become hot when used with cooking appliances.</p>
	<p>DISPOSAL: Do not dispose this product as unsorted municipal waste. Collection of such waste separately for special treatment is necessary. This product must not be disposed together with the domestic waste. This product has to be disposed at an authorized place for recycling of electrical and electronic appliances.</p> <p>By collecting and recycling waste, you help save natural resources, and make sure the product is disposed in an environmental friendly and healthy way.</p>

Important Information

Package of Range Hood

Please settle those packages carefully in order to protect environment.

Don't allow children to play plastic film and package, it may cause asphyxia. Please avoid children near package material.

Before use Range hood

This range hood exhaust fume outside.

Please read this manual and all information carefully before installation and operation. Please comply with our suggestion. If it's necessary, please read manual for gas hob. And please keep these manual carefully for future reference.

If range hood has obvious damage, please don't electrify and contact operator.

Product Description

Technical Data

Model	CXW-220-A852	Rated Power Input	224W
Power Supply	220-240V~ 50Hz	Turbo Power	264W
Nominal Wind Pressure	310Pa	Rated Main Motor Power Input	220W
Max static pressure	410Pa	Dimension (L×W×H)	(895×513×695)mm
Noise	53dB(A)	Net Weight	30.5kg

Note: 1. The performance test results are all in 230V~ 50Hz power supply environment. The airflow in according to IEC61591, the noise in according to IEC60704.

2. The determined value of nominal wind pressure,max static pressure shall not be less than 90% of declared value.

3. The noise declared value shown is A weighted sound pressure level, and the sound power level is A weighted sound pressure level plus 14 decibels.

Body Size

The marked sizes are for reference only, the depth dimension includes machine feet. (Unit: mm)

Note: The size inside the cabinet should be larger than the size with *.

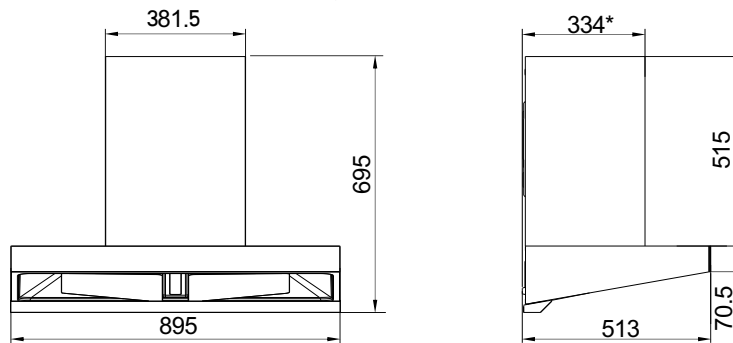

Packing List

After opening the box, please count the contents and load the stall and oil cup onto the hood before use.

Packing List	No.	Name	Quantity	No.	Name	Quantity
	1	Range hood	1	9	Baffle combination	1
	2	Ø185(outer diameter) aluminum exhaust pipe	1	10	Oil cup	1
	3	Exhaust pipe fixed strip		11	ST4.2×18 self-tapping screw	10
	4	Exhaust pipe tape		12	4×60 wood screw	4
	5	Exhaust pipe connection		13	Hitching foot stopper	1
	6	Plastic expansion pipe	4	14	M6 metal expansion pipe	1
	7	User manual	1	15	Hitching foot	1
	8	Check valve	1	16	ST4.2×8 self-tapping screw	6

Installation

 If the flue aperture is less than air duct aperture, it will influence the fume suction effect and the too long air duct will influence the fume suction effect, too.

Preparation for installation

●Surrounding

Keep the hood away from too many doors and windows, so as to avoid air convection affecting the efficiency.

●Tools preparation

The hood will be installed with the following tools

1.an impact drill (with drill bit); 2.a wrench; 3.a screwdriver; 4.a ruler.

Notice

- Installation and circuit setting must be done by experienced professionals. Only a professionally trained person with an installation qualification can install the hood. Non-professionals are not allowed to install, dismantle and repair the hood.
- Please do not power on the hood before installation to avoid electric shock.
- Do not expose the hood if your kitchen is under renovation, because construction materials, dusts, paint, coatings, and emitted gases will corrode and tarnish the hood surface. Therefore, it is recommended to install it after the renovation is completed.
- If you need move the Gas Hob before installing the Range Hood, please close the main valve before moving the Gas Hob.
- Don't install the hood on wood and other combustible walls. The wall shall be made of noncombustible materials with enough strength and the surface shall be flat.
- The hood may have very sharp edges. So, please wear protective gloves during hood installation, cleaning or repair.
- When drilling on the wall or ceiling board, keep away from embedded wires and other concealed devices to avoid electric shock and fire.
- Do not install the hood at a too high position as well as keep the hood free from disturbance of ambient airflow lest the reduction of smoke pumping effect shall occur.
- When making cabinet, please leave space for installation and disassembly of the hood in order to maintain and overhaul the hood.
- When installing, please keep the machine body remain horizontal.
- Please use single phase grounded socket and the hood shall be well grounded (water pipe grounding is not reliable and gas pipeline grounding has risks of causing fire disaster and explosion).
- In order to ensure safety and successful installation, please use standard accessories provided with the hood for installation, otherwise the hood may be at risk of falling down.
- If the power cord is damaged, in order to avoid danger, it must be replaced by manufacturer, professionals of its maintenance department or similar departments. Please do not carry out restructuring, stretching, knotting and squeezing or apply heavy objects to the power cord, etc., otherwise it may cause power cord damage easily, leading to accidents such as electric shock and fire disaster, etc.
- After installation, please clean the surface of the hood, and then supply power for test run.

Installation

Note: All data units in the following diagram are expressed in mm.

● Determine the position

The removable baffle can be adjusted according to the actual situations. The installation pitch of holes is shown in Figure 2. The hood body shall be centered vertically and kept level.

Ceiling hole size is shown in Figure 3. The socket location is recommended to be installed above the ceiling.

⚠ The hood shall be installed right above the hob. The minimum distance between the supporting surface for the cooking vessels on the hob and the lowest part of the range hood. When the range hood is located above a gas appliance, this distance shall be at least 650mm. If the instructions for installation for the gas hob specify a greater distance, this has to be taken into account.

Mounting hole of the drawing panel

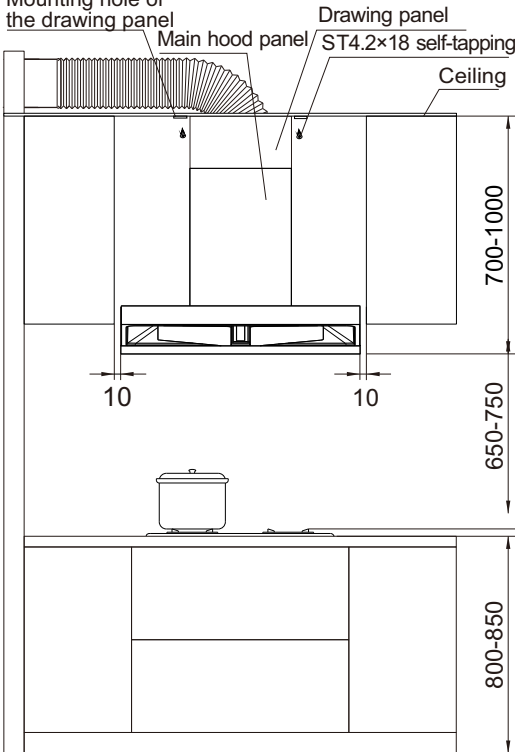

(Figure 1-1 Installation method of hood without removable baffle)

Figure 2

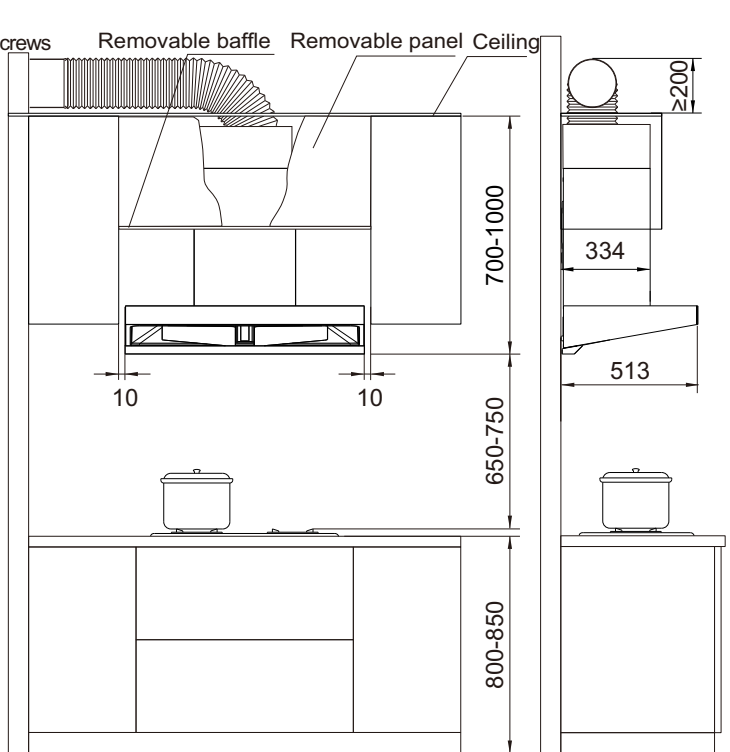

(Figure 1-2 Installation method of hood with removable baffle)

Figure 3

Hole size of the exhaust pipe $\varnothing 200$

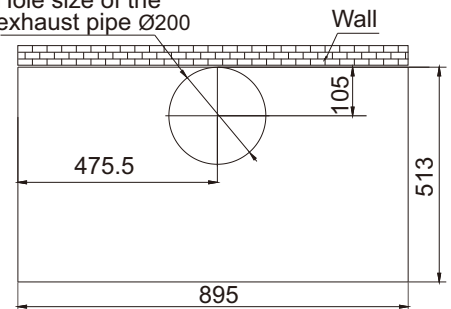

Ceiling hole sizes
(Projection size of the hood top)

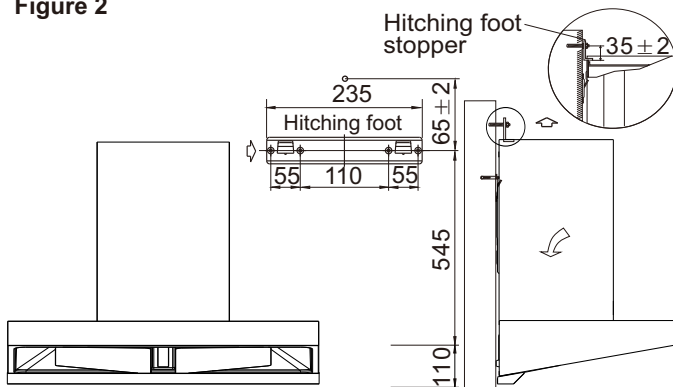

● Install hitching feet

According to the size of the hitching feet, drill four 60-70mm-deep holes on the wall accordingly with an 10mm-diameter drill bit (overlarge holes are prohibited). Press the expansion pipe into the holes, and then fix the hitching feet with 4 accompanying 4×60mm wood screws. Drill a hole with diameter of 10mm and depth of 50-55mm at the position 65mm above the four holes and insert the M6 metal expansion pipe into the hole. (Figure 2)

●Adjust drawing panel

Pull the two brackets of the drawing panel upwards to an appropriate height and then pull out the drawing panel by holding both sides. Remove the protective film (excluding cold plate materials) on the drawing panel and insert it along the gap between the main hood panel and the housing. Then adjust it to the proper height.

●Install hood body

Fix the check valve as shown in Figure 5. Then align the hanging holes in the back of hood with the hooks of hitching feet according to Figure 2, and press them together. Shake the body to check if it's hung securely. After the body is mounted, install the hitching foot stopper and gaskets to the M6 metal expansion pipe, and then tighten the nuts (to prevent accidental decoupling of the body under external force).

●Install drawing panel

As shown in Figure 1-1, there is certain gap between the drawing panel and the top plate. Push the panel against the top plate and then fix it to the top plate with ST4.2×18 screws.

(If installation method in Figure 1-2 is adopted, there's no need to adjust and install the drawing panel)

Note: If there is no host attached panel, no adjustment and installation is required.

Install the aluminum foil exhaust pipe

●Drilling position of the aluminum foil exhaust pipe (public flues do not require drilling)

- Aluminum foil exhaust pipe and hob facing the window: Remove one of the glasses and install a plywood with ventilation holes or punch directly on the glass.
- Hob away from the window: Install the aluminum foil exhaust pipe through the window that is close to the hob and connected outside; or install it by punching on the wall that is close to the hob and connected outside.
- Drill hole through the wall: Determine the location of the aluminum foil exhaust pipe against the wall and draw the drilling range (i.e. a circle slightly larger than the pipe OD). Then use a long drill bit to drill through the wall. Pay attention to the wall structure and material, so as not to destroy other parts of the wall.

●Link the aluminum foil exhaust pipe

Insert the end of aluminum foil exhaust pipe without fixed strip to the pipe connection and stick with tapes. Straighten the aluminum foil exhaust pipe and then connect the pipe to the connection of public flue outlet (straighten the pipe directly to the outdoor if there is no public flue). This can be done directly when the public flue connection or wall hole is larger than the pipe. Otherwise, there are four types of pipe connection small ends (OD: 140, 150, 160, 170 and 180 respectively) to be chosen from according to the hole size. Then cut the excess part with scissors.

Then, insert the end of the aluminum foil duct with the duct fixing strip into the outer ring of the check valve interface, and then fix it with three ST4.2×8 screws distributed and sealed with duct tape. Finally, put the four snaps of the check valve interface into the four slots of the check valve, and rotate clockwise to fix the duct on the check valve.

Figure 4

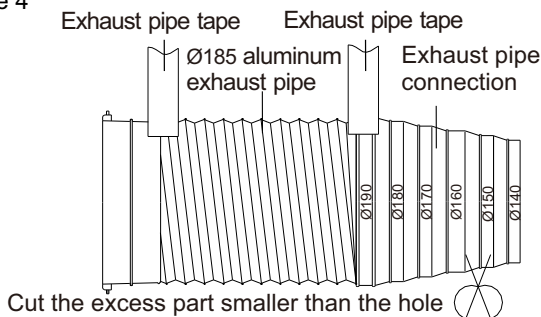

Note: During installation, straighten the aluminum exhaust pipe to avoid noises in semi-stretched state. Excess part may be cut with a wire cutter.

The exhaust wall hole diameter shall be close to that of the exhaust pipe, which shall not be too small. Otherwise, it will cause poor exhaust efficiency, more noises and lower airflow, etc. The connection between the pipe and the hole or the public flue must be sealed tightly to ensure that, the pipe and the check valve or public flue are connected securely. The blades at the check valve connection or public flue connection must be flexible. Suggestion: When the range hood is matched with the Boss anti-smoke back check valve, there is no need to install the check valve blade.

Figure 5

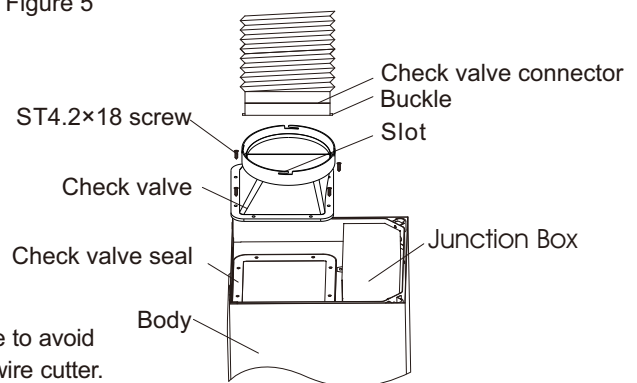

Installation of left and right baffles

● Remove the left and right baffles from the package first, then hang the hanging feet of the baffles into the machine hanging foot holes in the direction shown.

● Then push the baffle plate upward by hand so that the baffle plate touch bead shaft is inserted into the touch bead hole of the range hood as shown in the figure.

Note: The left and right baffles cannot be used together, and the oil leakage hole of the baffle is on the back side; the oil cup can only be installed after the baffle is installed.

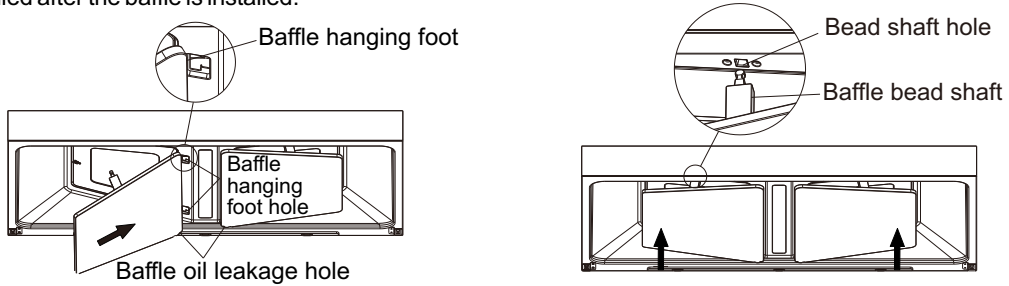

User Manual

Switch control panel

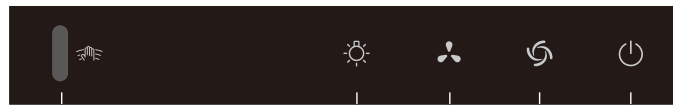





Hand wave induction

Lighting

Low Turbo/High Power

Turn on the power, the buzzer sounds to indicate the power-on state.

 <p>Lighting</p>	<p>Press the "Lighting" button, the lighting is on, then press the "Lighting" button, the lighting is off, the "Lighting" button only controls the lighting.</p>
 <p>Power</p>	<p>Press the "Power" button, the power button icon lights up long, the product is in the power on state.</p> <ol style="list-style-type: none"> 1.If only the lighting is on, pressing the "Power" button again will directly turn off the lighting. 2.If the fan is working, press the "Power" button again, the power button icon will flash and the hood will enter a delayed working state and automatically turn off all functions after 1 minute. 3.If the power button icon flashes when the "Power" button is pressed again, all functions will be turned off.
 <p>Turbo/High</p>	<p>In the power on state.</p> <ol style="list-style-type: none"> 1. Press the first time, enter the turbo gear, turbo/high gear icon flashing, after 3 minutes into the high gear, at this time the icon long light. 2. Press the second time, into the high gear, turbo/high icon light. 3. Press the third time, back to the turbo gear, turbo/high icon flashing.
 <p>Low</p>	<p>Press the "Low" button, the low gear icon lights up for a long time and the impeller rotates smoking at low speed.</p>
 <p>Hand wave induction</p>	<ol style="list-style-type: none"> 1. In the off state, the first wave of the hand automatically turns on the power ; the second wave of the hand turns on the turbo gear; the wave of the hand turns on the low gear function in the turbo gear. 2. In the off state, press and hold the "Turbo/High" button and the "Low" button at the same time to turn the sensor function on or off. If users are not used to this function, it is recommended to turn off its induction function.

Maintenance

Notice

●The hood shall be cleaned and maintained regularly depending on the surroundings, so as to keep its cleanness & efficiency and extend its service life.

We recommend that: Clean the outer surface of range hood after each cooking.

To ensure smooth discharge of fumes, the protective screening shall be cleaned regularly according to actual situations. Be careful to avoid damage when cleaning.

●It is recommended to use a neutral detergent to clean instead of strong detergents, and dry with a soft cloth. If your range hood is a mechanical switch, you should also avoid detergent touching each control key.

●Do not allow stains to stay on the surface of the hood for too long.

●Please do not use cleaning balls, brushes and other rough objects to clean the hood to prevent the body surface from scratching.

●When cleaning or maintaining the hood, please wear protective gloves to prevent wounding during wiping.

●Please check and clean the oil cup regularly. Hold the oil cup with both hands as shown on the right, pull it outward and pour off the waste oil.

●The range hood shall be started before cooking.

●Please unplug it during long-term shutdown, but please do not pull hard.

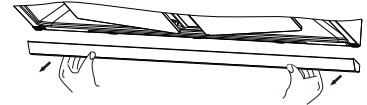

Removal of Components

Note: The installation procedures of the following components are in reverse with the removal. Please wear protective gloves during operation to prevent the sharp edge of metal hurting your hands.

⚠ Before installation or disassembly, the power must be disconnected to avoid electric shock.

Removal of lamp

●Unscrew the two screws on the small cover plate, remove the small cover plate, and pull out the connector.

●Use a small one-piece screwdriver or something relatively sharp and small to embed in the gap between the lamp cover and the fume hood installation.

●Pry it outward and remove the spotlight from the fume hood to replace the spotlight.

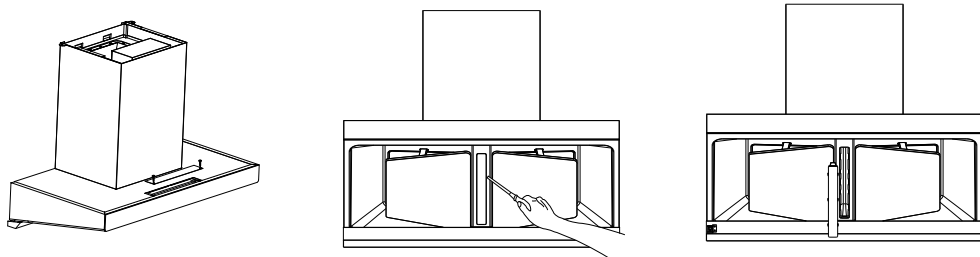

Lamp image		Lamp information	
	Lamp Type	Rectangular LED	
	Max Power	4W	
	Voltage	12VDC	
	Dimension	See the lamp image	

Removal of switch

- Remove the small cover plate by unscrewing the 2 screws on the small cover plate.
- Unscrew the 2 screws on the switch cover plate, rotate and flip out the switch cover plate, pull out the switch assembly, and repair or replace it.

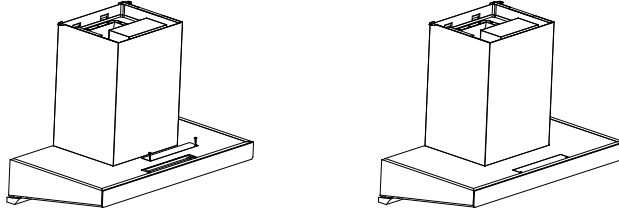

Removal of filter

- Remove the oil cup first, then pull the baffle plate downward with force by hand and remove the baffle plate in the direction shown in the figure.
- Align the Phillips screwdriver with the filter screen screw hole and force it upward slightly while rotating it about 90 degrees counterclockwise to disengage the screw from the fume hood snap slot.
- Then hold the bottom of the filter with one hand, hold the edge of the filter with the other hand, and then pull it out in the direction shown by the arrow to remove the filter.

Note: The left and right filters are removed in the same way, and the installation and removal steps are reversed.

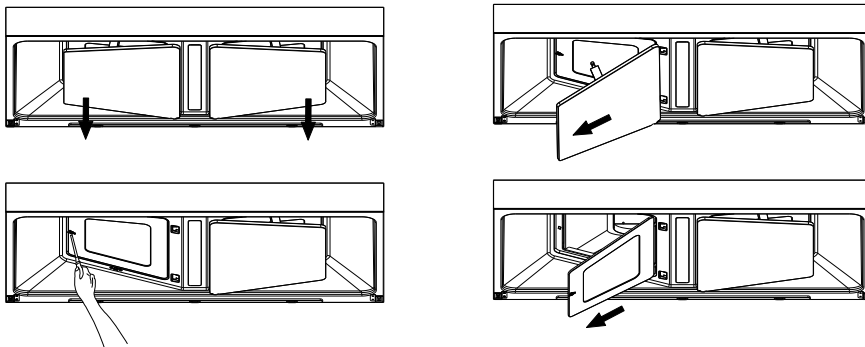

Removal the whole range hood

1. Unplug the power supply, remove the oil cup and take off the whole machine.
2. Unscrew the four screws at the rear of the mainframe panel, tilt the mainframe panel forward to a certain angle and then pull it out with upward force with both hands.
3. Remove the mainframe attachment panel from the mainframe panel.
4. Take out the noise reduction cotton, then use a Phillips screwdriver to screw down the fastening screws of the noise reduction panel and take out the noise reduction panel.
5. Turn down the fastening screw on the retaining ring and take out the retaining ring.
6. Unscrew the cap clockwise and take out the impeller vertically.

Install the impeller in the opposite way of the disassembly procedure. (When putting on the impeller, please put some lubricant in the shaft hole of the impeller.)

Note: Step 3 is not necessary if there is no host panel installed.

⚠ In general, the range hood body does not need to remove. The removal needs to be completed by professional maintenance staff.

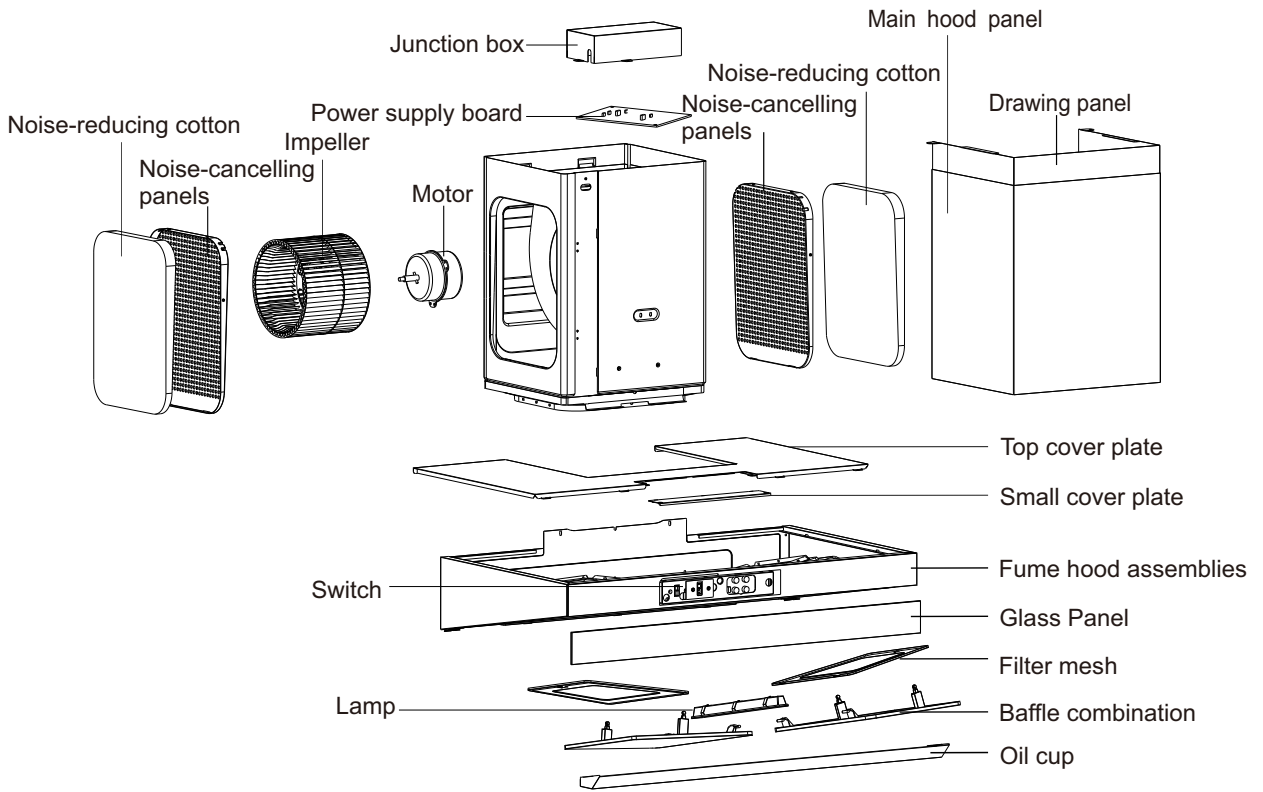

Circuit Diagram

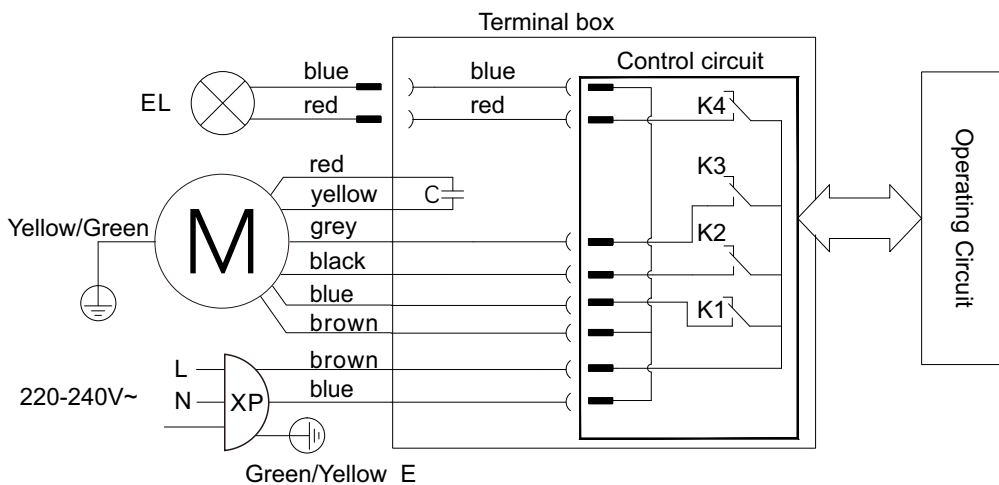

Troubleshooting of General faults

Fault	Cause	Solution	 Warning
No response after pressing any icon (e. g. the impeller does not rotate, or the light is off)	The power plug is not connected properly or there is power failure	Plug in the power plug	When connecting or replacing the plug, please unplug the power plug.
Pressing the lighting icon, the headlamp is not lit	The light is damaged or poorly connected	Replace the light or plug in the plug	
Induced current exists on the hood body may paralyze hands	The power socket is not grounded well	Use single-phase three-pole socket and well grounded	
Abnormal sound during impeller running	The impeller is loose, and the cap is not tightened	Tighten the cap	
No oil in the oil cup after a period of time	The hood body is tilt	Adjust the body to the horizontal state	

目 录

安全注意事项.....	1
重要信息.....	4
产品简介.....	5
装箱单.....	5
安装说明.....	6
使用说明.....	9
维护与保养.....	10
部件拆卸.....	10
线路图.....	12
一般故障的排除.....	13

亲爱的用户

承蒙您的厚爱，购买了老板吸油烟机，借此机会，向您表示深深的谢意！

在使用本产品前，请您仔细阅读本说明书，并妥善保管，以备将来参考。



*本说明书中的图片为示意图，仅供参考，若图片与实物不符，以实物为准。本公司产品外观结构不断改进，对于产品改进所引起的内容更改，恕不另行通知。

安全注意事项

为了避免给使用者及其他人员造成危害或者财产损失，特作如下区分及标志。

以下均为有关安全的重要事项，敬请严格遵守，并在充分理解内容的基础上正确使用。







根据危害、损害程度进行的内容区分

 危险	若忽视这一标志，并进行错误操作，极有可能导致人员危险、重伤或引起火灾。
 警告	若忽视这一标志，并进行错误操作，有可能导致人员危险、重伤或引起火灾。
 注意	若忽视这一标志，并进行错误操作，有可能导致人员受伤或造成物品的损害。

注意、禁止内容的图标

 禁止	 禁止明火	 禁止触摸	 禁止用潮湿的手操作	 禁止拆卸	 严格执行	 需要接地	 当心触电	 小心烫伤
---	--	--	---	--	--	---	--	--

 **警告** 请严格按照本说明书规定使用，由于本产品使用不当造成的任何财产损失、人身伤害，本公司不承担责任。

 危险	
 禁止	请不要让无人监护的儿童及体弱者单独使用吸油烟机，否则有可能导致触电或其他意外伤害。
 禁止	严禁电机、开关、接插件等电器部件沾水；禁止用水冲洗吸油烟机。吸油烟机被水淋湿后，请不要使用；如果使用会导致漏电、触电等事故。
 禁止	请不要对电源线进行改制、拉伸、结扣以及施加重物、挤压等，否则易导致电源线破损而发生触电和火灾事故。
 禁止	禁止私自改动吸油烟机内部布线，否则有可能会发生异常动作导致人体受伤；修理不妥还可能发生触电、火灾等危险。
 禁止用潮湿的手操作	请不要用潮湿的手触摸电源插头、电器部件以及操作电源开关，否则易发生触电事故。

危险



严格执行

在清洗吸油烟机、提供安装或维修服务之前，必须切断电源，以免触电。



严格执行

油锅着火时，请立即关闭吸油烟机（吸油烟机的运行会助燃火势），采用有效的灭火方法灭火。例如，用金属的盖子将明火盖住，立即关闭燃气总阀门，并使易燃物远离明火。



严格执行

出现异常现象时，将电源开关按到停止状态，拔下电源插头或者切断总电源，马上与本公司当地售后服务中心联系。异常状态下连续运转易发生触电、火灾等危险。

警告



禁止拆卸

非专业人员请勿拆卸、安装及维修吸油烟机。



禁止

炉火在不使用时应及时熄灭，禁止炉火直接烘烤吸油烟机。禁止在吸油烟机下直接烧烤食物，以免损坏吸油烟机及发生意外。



禁止触摸

请勿触摸已经开启或者刚关闭不久的灯泡，以免烫伤。



严格执行

为确保安全和安装顺利，请使用随机附件进行安装（特别是膨胀管和木螺钉，必须使用随机附件，否则吸油烟机有掉下来的危险）；安装金属膨胀管时，管径与孔径的配合必须紧密，严禁钻孔过大，以免膨胀管松动，造成吸油烟机意外跌落。



严格执行

吸油烟机应使用专用电源插座，并且专用电源插座可靠接地；因电源线中途连接、使用延长线以及多口配线器时易发生触电、插头插座发热以及火灾。请确保由专业的电工来进行，并且要严格按照所有适用的国家和地方的电力法规；在接线以前，请先关闭电源并采取合理措施防止电源开关自动闭合。



严格执行

如果电源软线损坏，为了避免危险，必须由制造商、其维修部或类似部门的专业人员更换。



严格执行

遵照加热设备厂家的安全指南，同时要遵照消防等管理部门颁布的安全标准进行。



严格执行







当吸油烟机与燃烧燃气或其它燃料的炉灶同时使用时，房间必须通风良好。









严格执行

本产品仅供家庭日常使用，请不要在特殊环境中使用（例如：室外）；也不能用来排出有危险的或者容易爆炸的物质或者气体。产品在安装前应安放在干燥、通风、周围无腐蚀性及其有害气体的环境中。

警告

 严格执行	吸油烟机的安装以及电路设置必须要由有经验的专业人员进行，非专业人员请勿安装。在安装时要遵守所有相关的法规、标准，包括与火灾有关的说明。用户自行安装易发生触电、脱落、起火等危险。
 严格执行	出风管必须确保接到室外。为了避免火灾的发生并保持空气清新，请将废气排到室外。请不要将废气排到墙内、阁楼或车库中。
 严格执行	如果不按说明书规定的方法清洗，吸油烟机有起火的危险。
 严格执行	请养成外出、就寝或使用后及时关闭灶具开关按钮及燃气总阀门，定期更换、检查煤气管道的习惯，煤气泄漏报警装置不能完全避免煤气泄漏事故。
 严格执行	器具不打算由存在肢体、感官或精神能力缺陷或缺少使用经验和知识的人（包括儿童）使用，除非有负责他们安全的人对他们进行与器具使用有关的监督或指导。应照看好儿童，确保他们不玩耍本器具。
 严格执行	灶台上烹饪容器的支承面与吸油烟机最低部位的最小距离。如果吸油烟机安装在燃气器具上方，该距离应至少为650mm。如果燃气灶台安装说明规定了更大的安装距离，则对此应予以考虑。

注意

 禁止	吸油烟机排出的气体不应排到用于排出燃烧燃气或其它燃料的烟雾使用的热烟道中。
 严格执行	在移动吸油烟机进行安装、清洁或者修理前，务必切断电源，以免触电；在进行安装、清洁或修理时，应佩戴防护手套，以防被吸油烟机内金属锐边伤手。
 严格执行	吸油烟机使用的环境温度不能超过40°C。
 严格执行	由于本吸油烟机的安装程序比较复杂，且重量较重，因此最好由专业安装维修人员按照说明书进行安装。
 严格执行	当进行切割或者在墙壁房顶上或者天花板上钻孔时，请注意不要损坏电线以及其它隐藏设备。
 严格执行	在密封性良好的建筑物中使用吸油烟机时，应保证有一空气入口，或将门稍打开一些，保证空气流通。

注意



当油杯内的积油超过三分之二或即将到达刻度线时，请及时清理，防止溢出。油杯中所收集的废油请勿食用。



安装吸油烟机的墙壁要有足够的支撑强度，对于中空墙壁，中空板实心层的厚度必须大于30mm以上，对于混凝土墙壁可直接打安装孔。整机必须牢固安装在墙壁上。



当使用烹饪器具时，易触及部件可能会发烫。



处置：请勿将本产品作为未分类的城市垃圾处置。需要单独收集这些废物进行特殊处理。本产品不得与生活垃圾一起处理。本产品必须在授权的地方处理，以回收电气和电子设备。通过收集和回收废物，有助于节约自然资源，并确保产品以环保和健康的方式处理。

重要信息

吸油烟机的包装

请以环保的态度处置这些包装材料，以保持一个良好的环境。

请勿让儿童玩耍塑料薄膜和包装箱，这可能会产生窒息事故，所以请让包装材料远离儿童，包装材料不是玩具。

使用吸油烟机前

该吸油烟机的排烟方式是外排式。

在您着手安装和使用本产品前，请充分阅读此说明书及随机附带的各个文件，并严格遵守，必要时请同时阅读你所购买的灶具使用说明书，并将他们妥善保存好，以备将来参考。

如发现吸油烟机有明显的损坏，请勿通电，并立即与当地的经销商或服务中心联系。

产品简介

技术参数

型号	CXW-220-A852	整机额定输入功率	224W
电源	220-240V~ 50Hz	爆炒档功率	264W
标称风压	310Pa	主电机额定输入功率	220W
最大静压	410Pa	外形尺寸 (长×宽×高)	(895×513×695)mm
噪声	53dB(A)	主机净重	30.5kg

注：1. 性能测试均为230V~ 50Hz电源环境下测试结果，风量测试标准依据IEC61591，噪声测试标准依据IEC60704。

2. 标称风压、最大静压的实测值不小于明示值的90%。

3. 所示噪声值为A计权声压级，声功率级为A计权声压级加14分贝。

机体尺寸

标注的尺寸仅供参考，其中进深尺寸含机脚。（单位：mm）

注意：橱柜内包尺寸应大于带*尺寸。

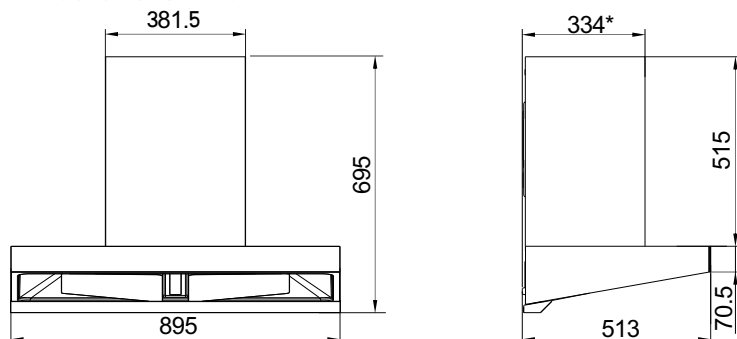

装箱单

开箱后请清点箱内物品，并在使用前将档板和油杯装到吸油烟机上。

装箱单	序号	名称	数量	序号	名称	数量
	1	吸油烟机	1台	9	挡板组合	1套
	2	Ø185(外径)铝箔风管	1套	10	油杯	1个
	3	风管固定条		11	ST4.2×18自攻螺钉	10枚
	4	风管接口		12	4×60木螺钉	4枚
	5	风管胶带		13	挂脚限位块	1个
	6	塑料膨胀管		4根	14	M6金属膨胀管
	7	使用说明书	1份	15	挂脚	1个
	8	止回阀	1套	16	ST4.2×8自攻螺钉	6枚

安装说明

 烟道口径小于风管口径会影响吸烟效果，风管过长也会影响吸烟效果。

安装前准备

●周围环境

吸油烟机应避免安装在门窗过多的地方，形成太大空气对流，而影响其除油排烟效果。

●工具准备

安装吸油烟机应准备以下工具：1. 冲击电钻（带钻头） 2. 扳手 3. 螺丝刀 4. 尺

注意事项

●吸油烟机的安装及电路设置必须由有经验的专业人员进行，只有经过专业培训的，并具有安装资质的人员，才能对吸油烟机进行安装，非专业人员请勿安装、拆卸及维修吸油烟机。

●安装前请勿接通吸油烟机电源，以免触电。

●如果您的厨房正处于装修状态，请勿将吸油烟机暴露在外，因为建筑材料、灰尘、油漆、涂料以及它们所挥发的的气体，会使吸油烟机表面产生腐蚀和失去光泽。因此建议您在装修完毕后再安装吸油烟机。

●如果在安装吸油烟机前，需要移动燃气灶，则在移动燃气灶前，请先关闭燃气总阀门。

●请勿将吸油烟机安装在木质等易燃物的墙面上，安装吸油烟机的墙面应为有足够强度的不可燃物，且表面平直。

●吸油烟机可能有非常锋利的边，在移动吸油烟机进行安装、清洁或修理时，请佩戴防护手套。

●在墙壁或天花板等上面钻孔时，应避开墙内埋设的电线及其它隐藏设备，以免引起触电及火灾。

●吸油烟机不要装得太高，也不要受外界气流干扰，以免降低吸烟效果。

●制作橱柜时，请给机体留下装取空间，以利维护保养与检修。

●装机时，请使机体保持水平。

●请使用单相带接地插座，并良好接地（自来水管接地不可靠，煤气管道接地有引发火灾与爆炸的危险）。

●为保证安全和安装顺利，请使用随机附件进行安装，否则吸油烟机可能会有掉下来的危险。

●如电源软线损坏，为了避免危险，必须由制造商、其维修部或类似部门的专业人员更换。请不要对电源线进行改制、拉伸、结扣以及施加重物、挤压等，否则易导致电源线破损而发生触电和火灾等事故。

●安装完毕后，请先对吸油烟机表面进行清洁，然后接通电源，进行试运行操作。

安装

注：以下示意图的所有数据单位均以mm表示。

●确定位置

可拆卸挡板根据实际安装情况适当调整。安装孔距如图2所示，机体应垂直居中和保持水平，吊顶钻孔尺寸如图3，插座位置建议安装在吊顶上方。

▲吸油烟机安装于炉灶正上方，炉灶上烹调器具的支承面与吸油烟机最低部位的最小距离为650mm(如煤气炉灶安装说明规定了较大的安装距离者，对此应予考虑。电灶可视实际情况适当降低)。

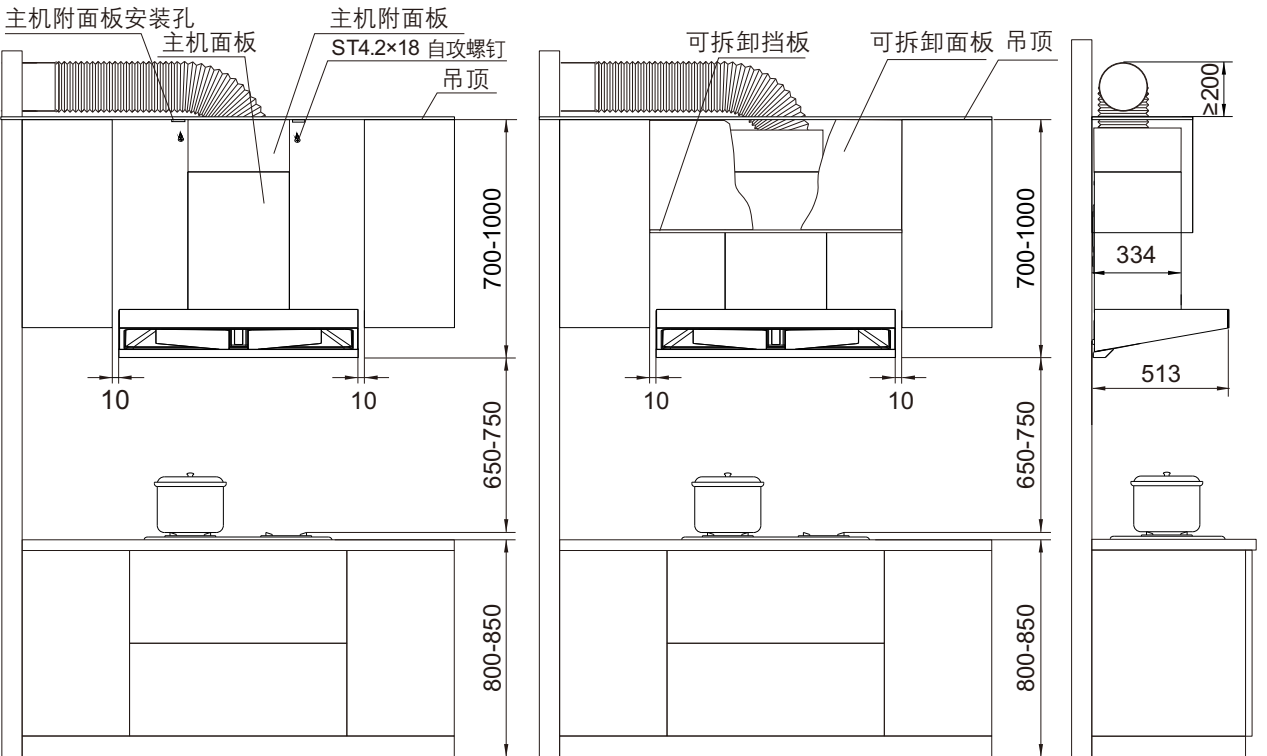

(图1-1无拆卸挡板的安装方法)

(图1-2有拆卸挡板的安装方法)

图2

挂脚限位块 图3

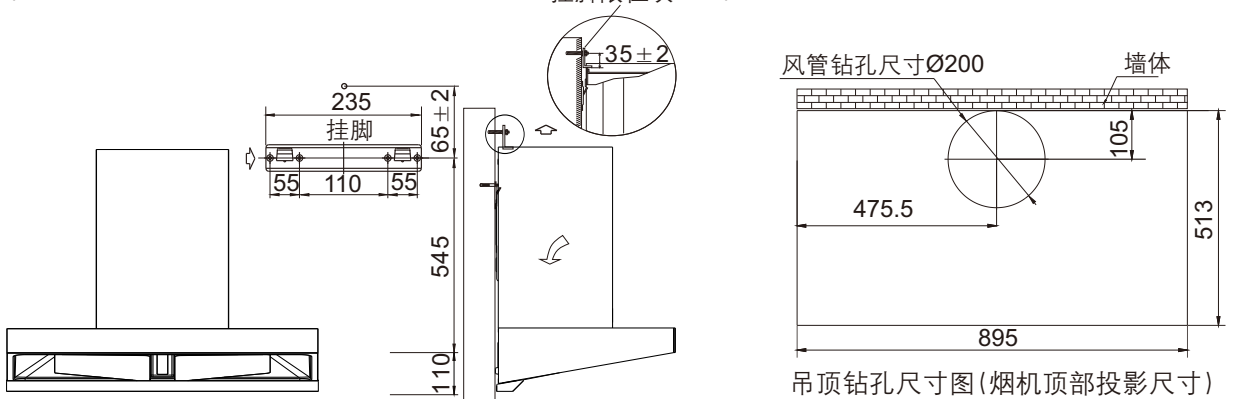

吊顶钻孔尺寸图(烟机顶部投影尺寸)

●安装挂脚

按照挂脚的尺寸在墙壁的相应位置上，用直径为10mm的钻头钻深度为60mm-70mm的四个孔（不可过大），将膨胀管压入孔内，再用随机配备的4枚4×60mm的木螺钉将挂脚可靠固定。在距离四孔高度65mm处，钻出一个直径为10mm（不可过大），深度为50mm-55mm的孔，将M6金属膨胀管塞入孔内。（如图2）

●调节主机附面板

双手拉动主机附面板的两个支架用力向上拔到适当高度，再用手拉住主机附面板的两边用力拉出主机附面板，撕去保护膜（若为冷板材质则无需撕膜），再沿主机面板与壳体之间的缝隙插入调整到适当的高度。

●安装机体

先将止回阀如图5所示固定，再按照图2所示将机体后部的挂孔对准挂脚的挂钩按压滑入，用手晃动机体看是否挂牢。待机体安装到位后，在M6金属膨胀管上装入挂脚限位块、垫片，旋紧螺母（防止机体在外力作用下意外脱钩）。

●安装主机附面板

如图1-1的安装方法，此时主机附面板与顶板之间还有一定的间隙，应将主机附面板推到与顶板接触，然后用ST4.2×18的螺钉将主机附面板固定在顶板上。（图1-2安装方法中无需调节与安装主机附面板）

备注：若无主机附面板，则无需调节与安装。

安装铝箔风管

●铝箔风管钻孔位置（公共烟道不需要钻孔）

- 铝箔风管与炉台正对窗户之安装：拆下一方玻璃，安装一块有排风孔的胶合板，或直接在玻璃上开洞。
- 炉台不临近窗户时：选择与炉台最近且可通室外的窗户，装设铝箔风管，穿窗而出；或选择与炉台最近且可通室外的墙壁打洞，装设铝箔风管，穿墙而出。
- 钻穿墙洞：先量好铝箔风管对墙位置，在壁面上画好钻孔范围（即比铝箔风管外径略大的圆形），再使用长钻头钻穿墙壁。钻孔时应注意墙壁结构和材料，切勿破坏墙洞以外的壁面。

●连接铝箔风管

先将铝箔风管无风管固定条一端套上风管接口用胶带贴住，并将风管拉直后与公共烟道接口进行连接（若无公共烟道的，请将风管拉直接至室外）。当公共烟道接口或墙孔大于铝箔风管时可以直接连接，当小于风管时，可选购风管接口。风管接口小端有外径140mm、150mm、160mm、170mm以及180mm五种规格，可根据实际情况，将小于公共烟道接口或墙孔的多余部分剪去。

然后，将铝箔风管带有风管固定条的一端插入止回阀接口外圈上，再用3颗ST4.2×8的螺钉分布固定，并用风管胶带密封。最后，把止回阀接口的四个卡扣放入止回阀的四个卡槽中，顺时针旋转即可将风管固定在止回阀上。

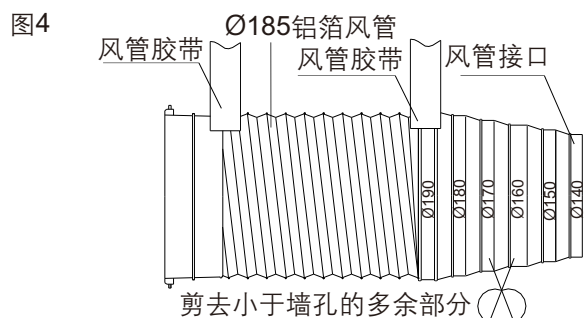

注意：安装时请将铝箔风管拉直，以免铝箔风管在半拉伸状态时产生噪音，多余部分可用钢丝钳剪去。

图5

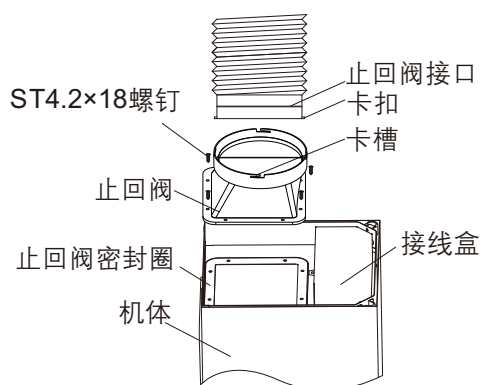

排风墙孔直径应与风管直径相近，不应太小，否则会造成排烟不畅、噪音升高、风量降低等情况。出风管与墙孔或公共烟道接口连接处必须严格进行密封，确保出风管与止回阀或公共烟道接口连接牢固，必须保证止回阀或公共烟道接口处的叶片开合灵活。建议：当吸油烟机与老板防回烟止回阀匹配使用时，无需安装止回阀叶片。

安装左右挡板

●先将左右挡板从包装中取出，然后按图所示方向将挡板的挂脚挂进机器挂脚孔中。

●然后用手向上推挡板，使挡板碰珠轴插进吸油烟机的碰珠孔中如图所示。

注意：左右挡板不能通用，挡板漏油孔在后侧；挡板安装好后方可安装油杯。

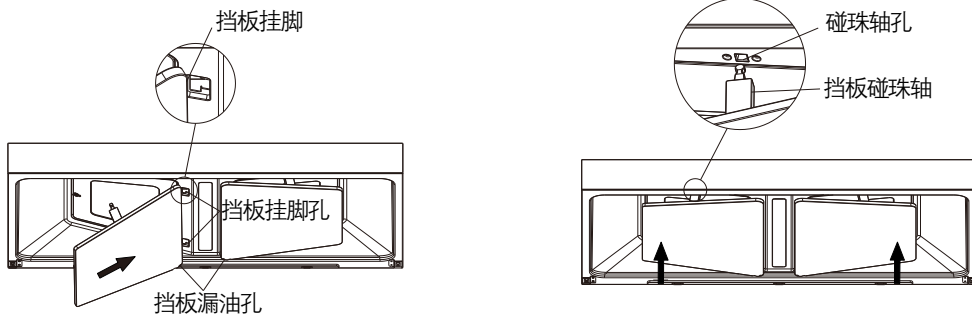

使用说明

开关控制面板

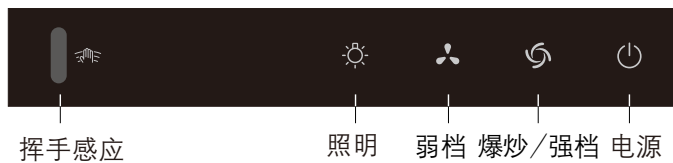

接通电源，蜂鸣器鸣响，提示进入通电状态。

	<p>按照明键，照明灯亮，再按照明键，则关闭照明灯，照明键只控制照明灯。</p>
	<p>按下电源键，电源键图标长亮，产品处于开机状态。</p> <ol style="list-style-type: none"> 1.如果只有照明灯亮，再按电源键将直接关闭照明灯； 2.如果风机正在工作时，再按电源键，电源键图标将闪烁，烟机进入延时工作状态，1分钟后自动关闭所有功能； 3.如果电源键图标闪烁时，再次按电源键，则关闭所有功能。
	<p>在电源开启状态下：</p> <ol style="list-style-type: none"> 1.按第一次，进入爆炒档，爆炒/强档图标闪烁，3分钟后转入强档，此时图标长亮； 2.按第二次，进入强档，爆炒/强档图标灯亮； 3.按第三次，回到爆炒档，爆炒/强档图标闪烁。
	<p>按下弱档键，弱档图标长亮，叶轮低速旋转吸烟。</p>
	<ol style="list-style-type: none"> 1.关机状态下，第一次挥手自动开启电源键；再次挥手响应爆炒功能；爆炒档状态下挥手响应弱档功能。 2.关机状态下，同时长按爆炒/强档键和弱档键，可将感应功能开启或关闭。若用户不习惯用此功能，建议将其感应功能关闭。

维护与保养

注意事项

●吸油烟机应视环境条件定期维护清洗，以保持机体清洁与使用效果，延长使用寿命。

我们建议：产品外表面在每次烹饪后都进行擦拭。

为保证油烟顺畅排出，请定期对网罩进行清洗，洗时请小心，以免损坏。

●请勿用强力洗涤剂，建议用中性洗涤剂清洗，并用软布擦干。如果您的吸油烟机为机械开关，应同时避免清洁剂接触各控制键。

●不要让污渍在吸油烟机表面停留时间过长。

●请不要使用清洁球、刷子等粗糙物对吸油烟机进行清洁，以防止划伤机体表面。

●清洁或保养吸油烟机时，请戴上防护手套，以防擦拭过程中受伤。

●请定期检查和清理油杯。如右图双

手拿住油杯，向外拉出，倒去废油。

●吸油烟机应在烹饪前开启。

●长期不使用时，请将电源插头拔出，但请勿用力拽拉。

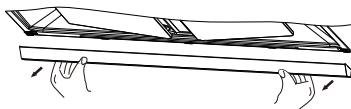

部件拆卸

注：以下部件的安装步骤与拆卸步骤相反，为防止金属锐边伤手，请在操作时佩戴好防护手套。

⚠ 在安装或拆卸之前，必须切断电源，以免触电。

灯拆卸

●拧下小盖板上的2颗螺钉，拆下小盖板，拔出连接器。

●用小的一字起子或比较尖小的东西嵌入灯罩与集烟罩安装之间的缝隙中。

●用力往外撬，把射灯从集烟罩上取出，即可更换射灯。

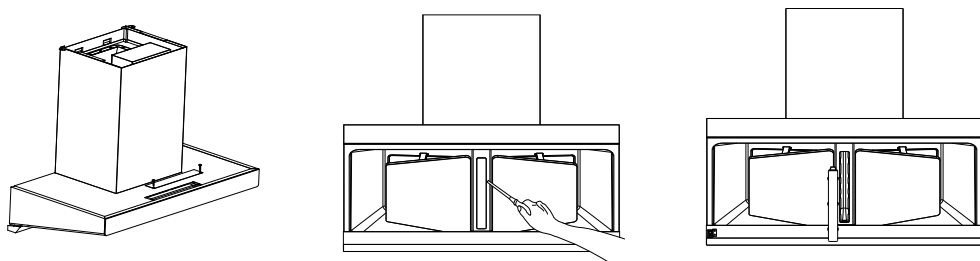

照明灯图形		照明灯信息	
	照明灯类型	长方形LED	
	最大功率	4W	
	电压	12VDC	
	尺寸	见照明灯图形	

开关拆卸

- 拧下小盖板上的2颗螺钉，拆下小盖板。
- 拧下开关盖板上的2颗螺钉，旋转翻出开关盖板，抽出开关组件，即可维修或更换。

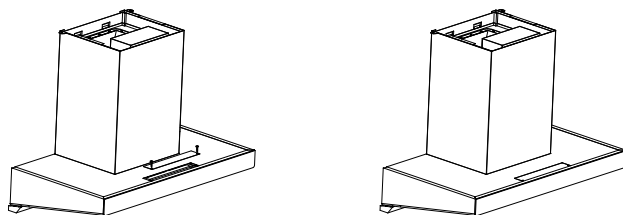

过滤网拆卸

- 先将油杯取出，然后手用力向下拉开挡板，按图所示方向将挡板取出。
 - 将十字螺丝刀对准过滤网螺钉孔，稍用力向上顶，同时逆时针旋转90度左右，使螺钉脱离集烟罩卡扣槽。
 - 然后单手托住过滤网底部，另一只手拿住过滤网边缘，再按箭头所示方向拉出，即可取出过滤网。
- 注意：左右两个过滤网拆卸方法一致，安装网罩方式和拆卸步骤相反。

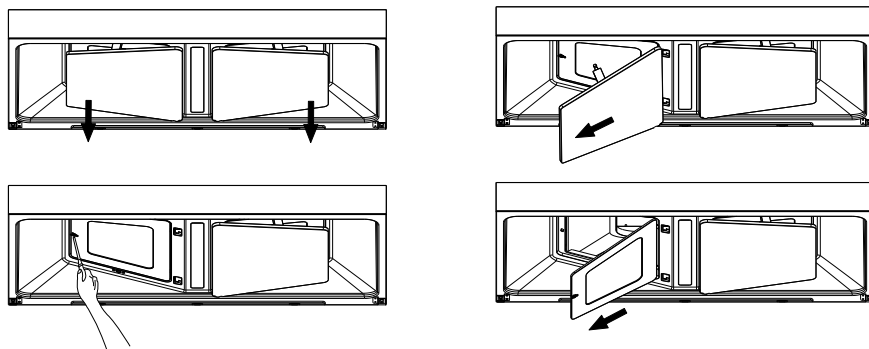

整机拆卸

1. 拔下电源插头，拆下油杯并取下整机；
2. 拧下主机面板后部的4枚螺钉，把主机面板向前倾斜到一定角度后，再用双手向上用力拔出；
3. 将主机附面板从主机面板中取出；
4. 取出降噪棉，然后用十字螺丝刀旋下降噪板的紧固螺钉，取出降噪板；
5. 旋下挡圈上的紧固螺钉，取出挡圈；
6. 顺时针旋下盖帽，垂直取出叶轮。

装上步骤与拆卸步骤相反。（装上叶轮时，请在叶轮的轴孔中抹一些润滑油。）

注：如没有安装主机附面板则无须步骤3

⚠️ 机体在一般情况下不需要拆卸。
拆卸工作需由专业维修人员来完成。

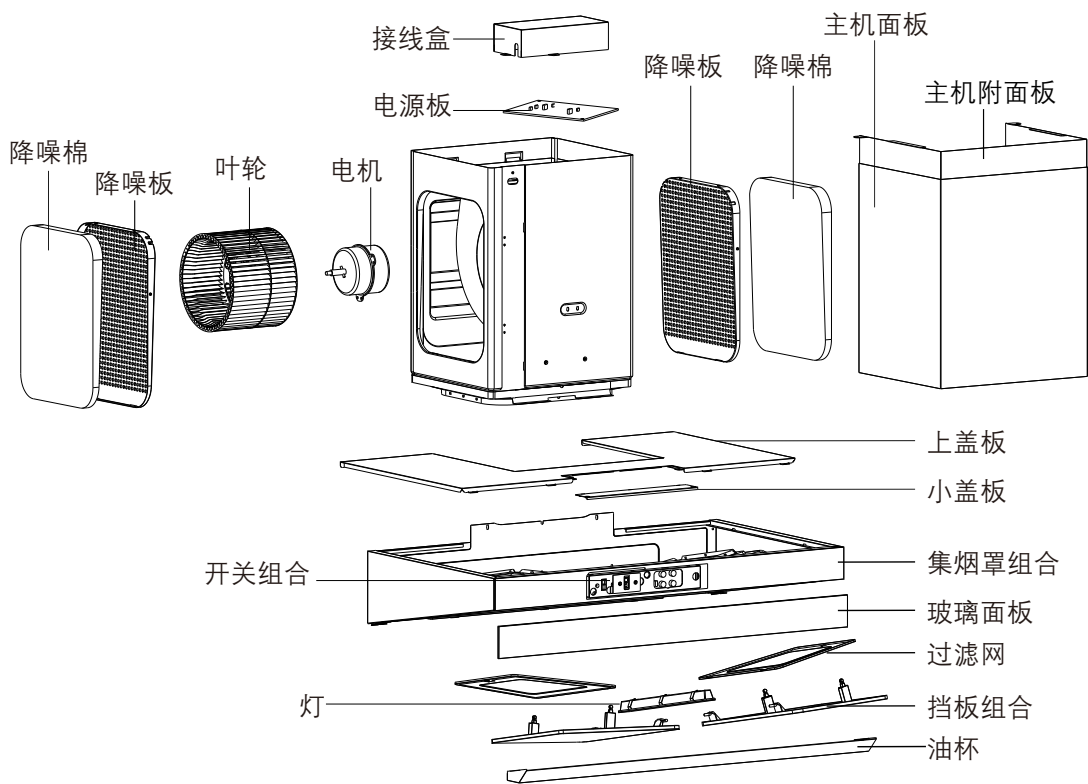

线路图

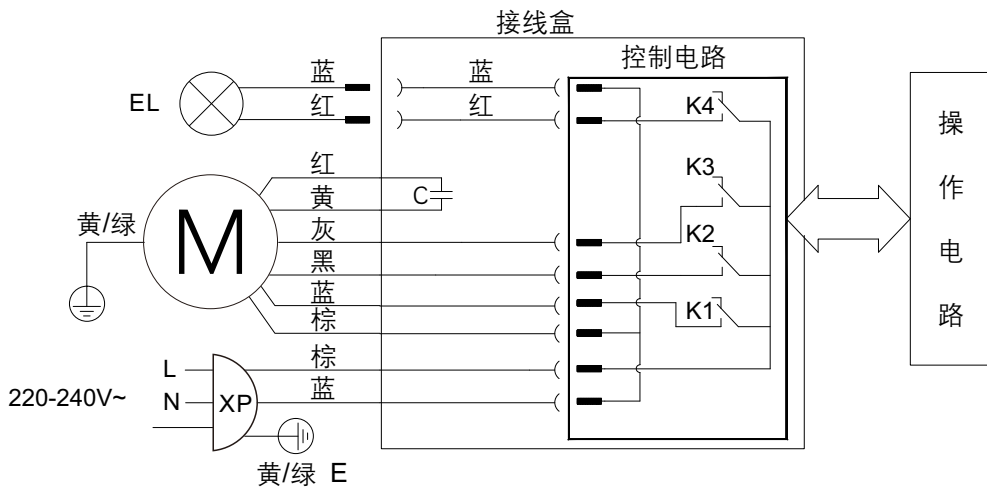

一般故障的排除

序号	故障现象	故障原因	排除方法	 警告
1	按任何键都无反应 (如叶轮不转动、照明灯不亮)	电源插头未插好或停电	插紧电源插头	在连接插件或更换时，务必拔下电源插头。
2	按照明键，照明灯不亮	照明灯损坏或照明灯接触不良	更换照明灯或插紧插件	
3	机体表面有感应电，麻手	电源插座没有良好接地	使用单相三极插座并良好接地	
4	叶轮运转有异常声	叶轮或电机支架紧固螺丝松动	旋紧叶轮固定螺钉	
5	使用一段时间后不见油滴入油杯	机体装置未呈水平，有倾斜	调整机体至水平状态	

版次: A/0

出版日期: 2021年6月20日

Edition: A/0

Publication Date: June, 20, 2021

ROBAM