

# ROBAM



## 使用说明书

User Manual

使用产品前请仔细阅读本使用说明书，并妥善保管。如果说明书丢失，你可以发送邮件至 [overseas@robam.com](mailto:overseas@robam.com)，获取电子版说明书。

Before operating this unit, please read the user manual completely and keep it. If the manual is lost, you can send e-mail to [overseas@robam.com](mailto:overseas@robam.com), request for an electronic manual.

### **CXW-260-A675S**

吸油烟机

Range Hood

# CONTENTS

Safety Precaution.....	1
Important Information.....	4
Product Description.....	5
Packing List.....	5
Installation.....	6
User Manual.....	8
Maintenance.....	10
Removal of Components.....	10
Circuit Diagram.....	12
Troubleshooting of General faults.....	12

### Dear users:



Thank for your buying our range hood. Please accept our best regards. Please read this user manual carefully before installation and operation.

\*The pictures in this manual only for your reference. If the picture isn't accord with object, subject to object. We keep to right to update appearance, structure or products without notice.

## Safety Precaution

In order to avoid harm or property damage to the users or other person, the following distinction and marks are stipulated. They are important safety precaution, please comply strictly based on the full understanding.

### Subject to harmful or destruct degree







 Danger	If ignore this sign and operate product improperly, it's highly possible to cause danger, serious injury or fire.
 Warning	If ignore this sign and operate product improperly, it's possible to cause danger, serious injury or fire.
 Notice	If ignore this sign and operate product improperly, it's possible to cause injury or loss.

### Notice and Prohibit Mark



 Prohibit	 Prohibit Flame	 Prohibit Touch	 Prohibit Touch by Wet Hand	 Prohibit Disassembly	 Strict Execution	 Necessary Earthed	 Caution Electric Shock	 Caution Scald
---	--	--	--	--	--	--	--	---

 Warning Please use this product according to manual strictly, or ROBAM shall not take any responsible caused by improper operation.









## Danger

 Prohibit	Don't allow children or weakling to use range hood separately, or it may cause electric shock or other accident.
 Prohibit	Prohibit water on motor, switches or other electric parts; Prohibit wash range hood by water spray. Don't use range hood if wet or it may cause electric leakage or shock.
 Prohibit	Don't change, stretch, bind or press electric wire, or it's possible to cause electric shock or fire because of broken wire.
 Prohibit	Prohibit any change of interior circuit, or it may cause injury or other danger, for example, electric shock or fire.
 Prohibit Touch by Wet Hand	Don't touch plug, electric parts or button by wet hands, or it may cause electric shock.
 Strict Execution	Unplug before cleaning, installing or maintaining, avoiding from electric shock.







### Danger

 Strict Execution	Please turn off range hood immediately if pan got fire (range hood shall aggravate fire if it's working) and extinguish fire by effective action. For example, cover flame by metal cover, turn off gas valve immediately and remove inflammable things.
 Strict Execution	Any abnormal, please turn off power, take off plug or cut off electric source, and contact service. It's possible to cause electric shock or fire if using range hood under abnormal situation.



### Warning

 Prohibit Disassembly	Range hood must be installed, disassembled or maintained by professional person.
 Prohibit	Stove fire shall be extinguished timely when it is not used; do not flambe under the range hood and it's prohibited to bake food under range hood directly to prevent range hood from damaging and causing accidents.
 Prohibit Touch	Don't touch bulb if it's on or just close in short time, or it may cause scald.
 Strict Execution	In order to ensure safety, range hood must be installed by specific accessory (especially expansion pipe and wooden screws, or it may cause accidental drop of range hood). The pipe bore and hole must fit tightly during the installation of metal expansion pipe. It is prohibited to make excessively large hole to prevent accidental drop of loosening expansion pipe.
 Strict Execution	The range hood must be used by specific plug and properly ground it. It's possible to cause electric shock, hot plug or fire because of improper electric wire. Installation must be executed by professional person based on local electrical regulations. Before connect electricity, power must be turned off.
 Strict Execution	If the supply cord is damaged, it must be replaced by the manufacturer, its service agent or similarly qualified persons in order to avoid a hazard.
 Strict Execution	All operation must comply with our safety guidelines as well as local safety regulations.
 Strict Execution	There shall be adequate ventilation of the room when the range hood is used at the same time as appliances burning gas or other fuels.







## Warning

 Strict Execution	This appliance just for household use only. And it's not allowed to exhaust dangerous or explosive matter or air. It should be put under dry and ventilation environment without dangerous air.
 Strict Execution	The range hood and electric circuit must be installed by skilled and trained personnel with required qualification. When installation, the related regulation, standard or instruction on fire must be complied. It may cause danger because of improper installation, for example, electric shock, drop or fire accident.
 Strict Execution	The outlet must be connect with outside. In order to ensure safety and fresh air, waste gas should be exhaust to outside. Don't exhaust waste gas to the wall, loft or garage.
 Strict Execution	There is a fire risk if cleaning is not carried out in accordance with the instructions.
 Strict Execution	Keep a good habit to turn off gas hob and gas valve if go outside, sleep or finish operation. Replace or check gas pipe regularly, since gas alarm device can't completely avoid accident caused by gas leakage.
 Strict Execution	This appliance is not intended for use by persons (including children) with reduced physical, sensory or mental capabilities, or lack of experience and knowledge, unless they have been given supervision or instruction concerning use of the appliance by a person responsible for their safety. Children should be supervised to ensure that they do not play with the appliance.
 Strict Execution	The minimum distance between the supporting surface for the cooking vessels on the hob and the lowest part of the range hood. When the range hood is located above a gas appliance, this distance shall be at least 650mm. If the instructions for installation for the gas hob specify a greater distance, this has to be taken into account.

## Notice

 Prohibit	The air must not be discharged into a flue that is used for exhausting fumes from appliances burning gas or other fuels, the discharge of air must fulfill the requirements of local regulations.
 Strict Execution	Before removing range hood for installation, clean or maintainance, power must be cut off avoiding from electric shock. When installation, clean or maintainance, protective gloove must be wear avoiding from injury.
 Strict Execution	The temperature for range hood working can't exceed 40°C.

### Notice

 <b>Strict Execution</b>	<p>Because the installation is difficult and hood is heavy, the installation shall be executed by professional person based on manual.</p>
 <b>Strict Execution</b>	<p>Don't break electric wire or other invisible equipment when cutting something or drilling holes on ceiling.</p>
 <b>Strict Execution</b>	<p>When range hood is using in well sealed building, it should have air inlet or open door to ensure good ventilation.</p>
 <b>Strict Execution</b>	<p>When the oil exceeds 2/3 or near tick mark in the oil cup, clean it in time. Don't eat waste oil from oil cup.</p>
 <b>Strict Execution</b>	<p>The wall of installing range hood needs enough strength. For hollow walls, the thickness of solid layer of hollow wall must be more than 30mm, but for concrete walls, it can be drill holes directly. The range hood must be fixed on the wall firmly.</p>
 <b>Strict Execution</b>	<p>Accessible parts may become hot when used with cooking appliances.</p>
	<p><b>DISPOSAL:</b> Do not dispose this product as unsorted municipal waste. Collection of such waste separately for special treatment is necessary. This product must not be disposed together with the domestic waste. This product has to be disposed at an authorized place for recycling of electrical and electronic appliances.</p> <p>By collecting and recycling waste, you help save natural resources, and make sure the product is disposed in an environmental friendly and healthy way.</p>

## Important Information

### Package of Range Hood

Please settle those packages carefully in order to protect environment.

Don't allow children to play plastic film and package, it may cause asphyxia. Please avoid children near package material.

### Before use Range hood

This range hood exhaust fume outside.

Please read this manual and all information carefully before installation and operation. Please comply with our suggestion. If it's necessary, please read manual for gas hob. And please keep these manual carefully for future reference.

If range hood has obvious damage, please don't electrify and contact operator.

This manual is available for different models. So you may find different description with your own range hood.

## Product Description

### Technical Data

Model	CXW-260-A675S	Rated Power Input	262W
Power Supply	220-240V~ 50-60Hz	Rated Main Motor Power Input	260W
Nominal Wind Pressure	500Pa	Dimension (L×W×H)	(895×410×668)mm
Max static pressure	1000Pa	Net Weight	29.8kg
Noise	50dB (A)		

#### Note:

1. The performance test results are all in 230V~ 50Hz power supply environment. The noise in according to IEC 60704.
2. The tolerance between listed of nominal wind pressure, max static pressure and actual data should be less than 10%.
3. The noise declared value shown is A weighted sound pressure level.

### Body Size

The marked sizes are for reference only, the depth dimension includes machine feet. (Unit: mm)

Note: The size inside the cabinet should be larger than the size with \*. 326mm is the depth dimension excluding the main panel, and 331mm is the depth after matching the main panel.

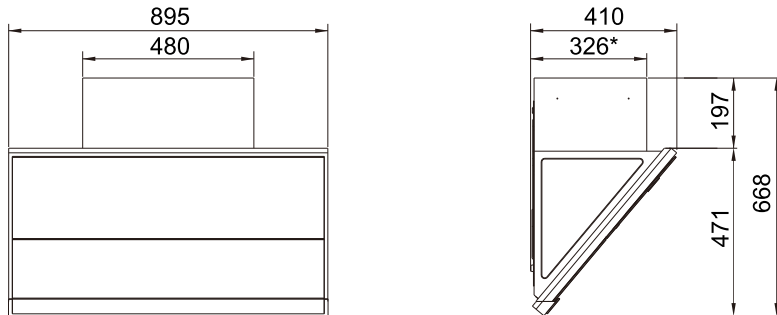

## Packing List

Please check the contents of the box after unpacking

装箱单	No.	Name	Quantity	No.	Name	Quantity
	1	Range hood	1	8	ST4.2×18 self-tapping screw	6
	2	∅185(outer diameter) aluminum exhaust pipe	1	9	ST4.2×8 self-tapping screw	6
	3	Exhaust pipe fixed strip		10	4×60 wood screw	4
	4	Exhaust pipe tape		11	M6 metal expansion pipe	1
	5	Exhaust pipe connection		12	Hitching foot stopper	1
	6	User manual		13	Hitching foot	1
	7	Check valve	1	14	Plastic expansion pipe	4

## Installation

 If the flue aperture is less than air duct aperture, it will influence the fume suction effect and the too long air duct will influence the fume suction effect, too.

### Preparation for installation

#### ● Surrounding

Keep the hood away from too many doors and windows, so as to avoid air convection affecting the efficiency.

#### ● Tools preparation

The hood will be installed with the following tools

### Notice

- Installation and circuit setting must be done by experienced professionals. Only a professionally trained person with an installation qualification can install the hood. Non-professionals are not allowed to install, dismantle and repair the hood.
- Please do not power on the hood before installation to avoid electric shock.
- Do not expose the hood if your kitchen is under renovation, because construction materials, dusts, paint, coatings, and emitted gases will corrode and tarnish the hood surface. Therefore, it is recommended to install it after the renovation is completed.
- If you need move the Gas Hob before installing the Range Hood, please close the main valve before moving the Gas Hob.
- Don't install the hood on wood and other combustible walls. The wall shall be made of noncombustible materials with enough strength and the surface shall be flat.
- The hood may have very sharp edges. So, please wear protective gloves during hood installation, cleaning or repair.
- When drilling on the wall or ceiling board, keep away from embedded wires and other concealed devices to avoid electric shock and fire.
- Do not install the hood at a too high position as well as keep the hood free from disturbance of ambient airflow lest the reduction of smoke pumping effect shall occur.
- When making cabinet, please leave space for installation and disassembly of the hood in order to maintain and overhaul the hood.
- When installing, please keep the machine body remain horizontal.
- Please use single phase grounded socket and the hood shall be well grounded (water pipe grounding is not reliable and gas pipeline grounding has risks of causing fire disaster and explosion).
- In order to ensure safety and successful installation, please use standard accessories provided with the hood for installation, otherwise the hood may be at risk of falling down.
- If the power cord is damaged, in order to avoid danger, it must be replaced by manufacturer, professionals of its maintenance department or similar departments. Please do not carry out restructuring, stretching, knotting and squeezing or apply heavy objects to the power cord, etc., otherwise it may cause power cord damage easily, leading to accidents such as electric shock and fire disaster, etc.
- After installation, please clean the surface of the hood, and then supply power for test run.



## Installation

Note: All data units in the following diagram are expressed in mm.

● Determine the position: the reserved size of the cabinet is shown in Fig. 1, the drilling size of the suspended ceiling is shown in Fig. 2, and the socket position is recommended to be installed above the suspended ceiling.

Figure 1

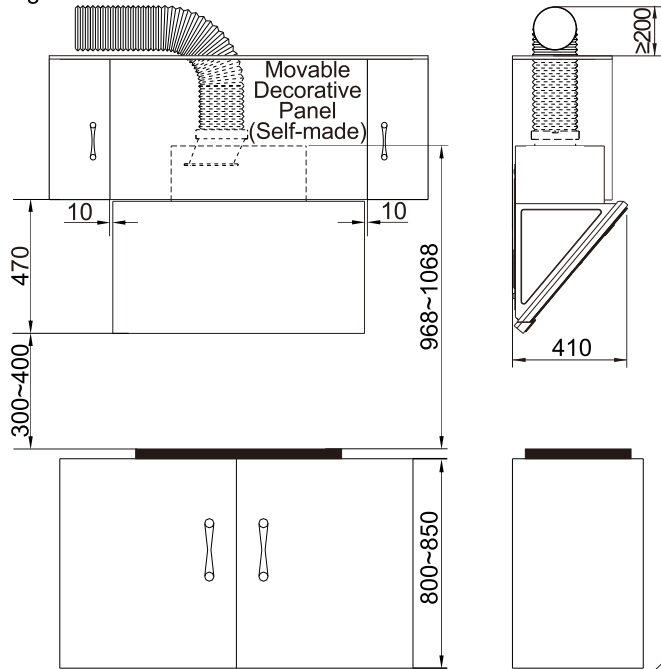

Cabinet dimension is for reference only

Figure 3

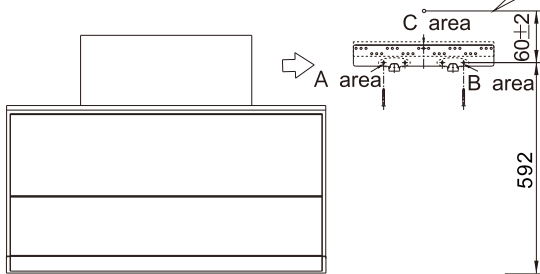
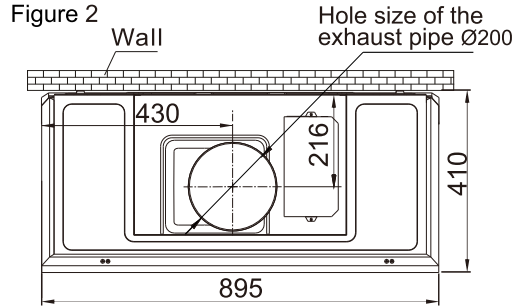
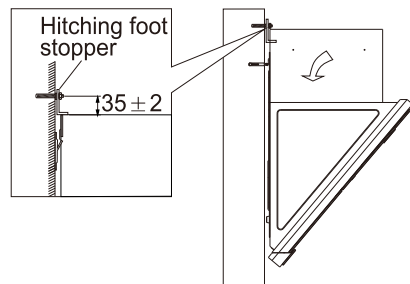
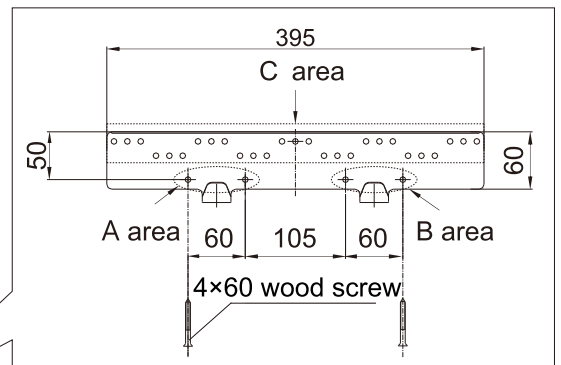

Figure 2



Ceiling hole sizes(Projection size of the hood top)



● **Install hitching feet:** According to the size of the hitching feet, drill four 60mm-70mm-deep holes on the wall accordingly with an 10mm-diameter drill bit (overlarge holes are prohibited). Press the expansion pipe into the holes, and then fix the hitching feet with 4 accompanying 4x60mm wood screws. Drill a hole with diameter of 10mm and depth of 50mm-55mm at the position 60mm above the four holes and insert the M6 metal expansion pipe into the hole. (Figure 3)

Note:1. Area A and B on the drawing must be fixed with screws respectively (at least one for each area);

2. If it is a wooden house, one screw (at least one) must be fixed at the corresponding wooden column in Area C.

● **Install the hood body**

Fix the check valve as shown in Figure 5. Then align the hanging holes in the back of hood with the hooks of hitching feet according to Figure 3, and press them together. Shake the body to check if it's hung securely. After the body is mounted, install the hitching foot stopper and gaskets to the M6 metal expansion pipe, and then tighten the nuts (to prevent accidental decoupling of the body under external force).

## Install the aluminum exhaust pipe

### ● Drilling position of the aluminum exhaust pipe (public flues do not require drilling)

- Aluminum exhaust pipe and hob facing the window: Remove one of the glasses and install a plywood with ventilation holes or punch directly on the glass.
- Hob away from the window: Install the aluminum exhaust pipe through the window that is close to the hob and connected outside; or install it by punching on the wall that is close to the hob and connected outside.
- Drill hole through the wall: Determine the location of the aluminum exhaust pipe against the wall and draw the drilling range (i.e. a circle slightly larger than the pipe OD). Then use a long drill bit to drill through the wall. Pay attention to the wall structure and material, so as not to destroy other parts of the wall.

### ● Link the aluminum exhaust pipe

Insert the end of aluminum exhaust pipe without fixed strip to the pipe connection and stick with tapes, then straighten the aluminum exhaust pipe and connect it to the public flue outlet (If there is no public flue, please straighten the aluminum exhaust pipe to the outdoors). This can be done directly when the public flue outlet or wall hole is larger than the aluminum exhaust pipe. Otherwise, there are five types of pipe small ends (OD:140,150,160,170 and 180 respectively) to be chosen from according to the hole size. Then cut the excess part smaller than public flue outlet or wall hole with scissors.

Then insert the end of the aluminum exhaust pipe with fixed strip in the outer ring of the check valve connection and seal with exhaust pipe tapes. At last, put four snaps of the check valve connection in corresponding slots, and rotate them clockwise to fix the exhaust pipe to the check valve.

Figure 4

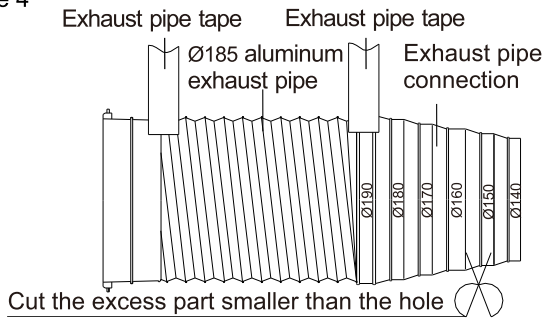

Note: During installation, straighten the aluminum exhaust pipe to avoid noises in semi-stretched state. Excess part may be cut with a wire cutter.

**The exhaust wall hole diameter shall be close to that of the exhaust pipe, which shall not be too small. Otherwise, it will cause poor exhaust efficiency, more noises and lower volume, etc. The connection between the pipe and the hole or the public flue must be sealed tightly to ensure that, the pipe and the check valve or public flue is connected securely. The blades at the check valve connection or public flue connection must be flexible.**

Figure 5

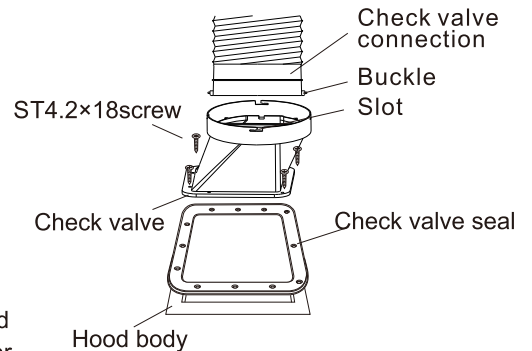



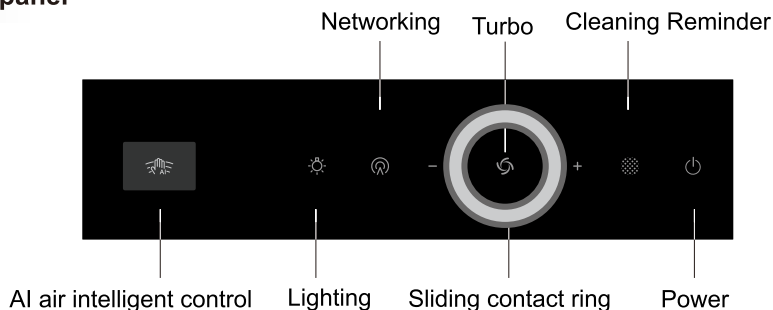

## User Manual

### Switch control panel

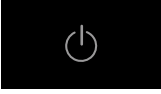

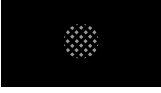
When the power supply is turned on, the buzzer sounds, all the indicator lights are on and go out after a few seconds, indicating that the power is on.

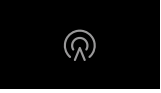
 <p>Power</p>	<p>Press the power key to enter the power-on state, and the icon of the power key is on.</p> <ol style="list-style-type: none"> <li>1. If the fan is working when the power is turned on, press the power button, the icon of the power button will flash, and the hood will enter the delayed working state, and the hood will be turned off after 1 minute. When the power button flashes, press the power button again to turn off the hood directly.</li> <li>2. In the power-on state, if no function runs within 3 minutes, it will automatically shut down.</li> </ol>
 <p>Sliding contact ring</p>	<ol style="list-style-type: none"> <li>1. Slide clockwise or click on the right half of the ring to adjust the large air volume, up to the stir-frying gear;</li> <li>2. Slide counterclockwise or click on the left half of the ring to adjust the air volume to the minimum of closing;</li> <li>3. Ring display: The whole circle of blue breathing is displayed when the air volume is stir-fried; The whole circle of blue is displayed when the air volume is strong; When the air volume is weak, the whole circle is white.</li> </ol>
 <p>Turbo</p>	<ol style="list-style-type: none"> <li>1. Press the stir-fry button, the stir-fry icon is always on, the ring blue is all on, and the breathing effect is displayed, thus entering the stir-fry state. After 3 minutes, it automatically switches to the strong gear, the ring stops breathing, changes to blue and lights up, and the stir-fry icon goes out;</li> <li>2. Press this button again in the stir-fry state, the icon and ring will go out, and the fan will stop working.</li> </ol>
 <p>Cleaning Reminder</p>	<ol style="list-style-type: none"> <li>1. When the hood runs for 60 hours, the cleaning reminder icon flashes to remind the user to clean the oil net;</li> <li>2. Press and hold the cleaning reminder button for a long time, and the icon is always on, and enter the cleaning mode (the fan stops, the lighting lamp and the air deflector are turned on, and the other buttons are invalid except the cleaning reminder button and the lighting button);</li> <li>3. The user must clean the oil net by himself. After cleaning, press this button for a long time, the cleaning reminder icon goes out, the cleaning mode is exited, and the accumulated time is cleared.</li> </ol>
 <p>Lighting</p>	<p>Turn on or off the lighting lamp according to the open key. When turned on or off, the lighting lamp is gradually turned on or off.</p>
 <p>AI air intelligent control</p>	<ol style="list-style-type: none"> <li>1. Suspending in front of the sensing area can control the turning on and off of the machine and switch the lights synchronously, waving from left to right to control the big air volume stir-fry and strong gear switch, and waving from right to left to control the small air volume weak gear and close switch;</li> <li>2. In the shutdown state, press the stir-fry button and cleaning reminder button for a long time to turn off or turn on the sensing function, and press the stir-fry button and lighting button for a long time to turn off or turn on the automatic lighting function for gesture startup.</li> </ol>
 <p>Networking</p>	<ol style="list-style-type: none"> <li>1. When the power key is on, press the networking key for a long time to enter the networking configuration state. The networking icon flashes. After networking is successful, the icon lights up for a long time. If the network is not successfully connected for 3 minutes, the icon will stop flashing and go out.</li> <li>2. When the networking is successful and the network is normal, the networking icon will be on for a long time when the network is turned on, and the icon will go out when the network is turned off.</li> </ol>

## Maintenance

### Notice

●The hood shall be cleaned and maintained regularly depending on the surroundings, so as to keep its cleanness & efficiency and extend its service life.

We recommend that: Clean the outer surface of range hood after each cooking.

To ensure smooth discharge of fumes, the protective screening shall be cleaned regularly according to actual situations. Be careful to avoid damage when cleaning.

●It is recommended to use a neutral detergent to clean instead of strong detergents, and dry with a soft cloth. If your range hood is a mechanical switch, you should also avoid detergent touching each control key.

●Do not allow stains to stay on the surface of the hood for too long.

●Please do not use cleaning balls, brushes and other rough objects to clean the hood to prevent the body surface from scratching.

●When cleaning or maintaining the hood, please wear protective gloves to prevent wounding during wiping.

●Please regularly check and clean the oil cup. As shown in the right figure, hold the oil cup with both hands, pull it out and pour out the waste oil.

●The range hood shall be started before cooking.

●Please unplug it during long-term shutdown, but please do not pull hard.



## Removal of Components

Note: The installation procedures of the following components are in reverse with the removal. Please wear protective gloves during operation to prevent the sharp edge of metal hurting your hands.

⚠ Unplug before installing or disassembling, avoiding from electric shock.

### Removal of lamp

●Long press the cleaning reminder button to open the air deflector, and then unplug the power plug. Insert a flat screwdriver into the gap between the lamp and the air deflector, and pry out the lamp for maintenance and replacement.

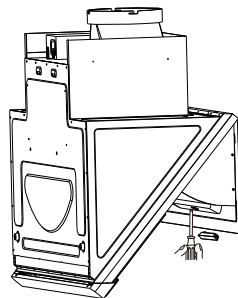

Lamp image		Lamp information	
	Lamp Type	Rectangular LED	
	Max Power	2W	
	Voltage	12VDC	
	Dimension	See the lamp image	

## Removal of switch

- Press the cleaning reminder key for a long time to open the air deflector, and then pull off the power plug.
- Unscrew two screws on the noise reduction plate with a screwdriver, and take out the noise reduction plate and the noise reduction cotton. After unscrewing a screw in the middle of the cover plate, take out the switch combination and unplug the connecting wire, and then repair and replace it.

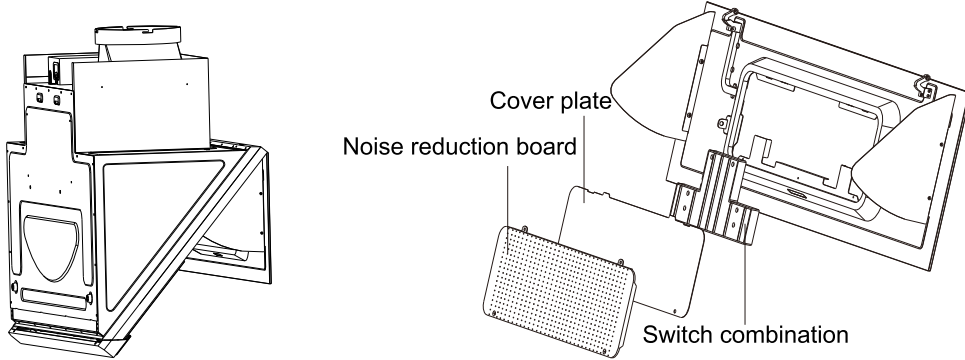

## Removal of filter

- Press the cleaning reminder key for a long time to open the air deflector.
- Hold the two magnetic clasps on the filter screen with both hands, apply a little force outwards so that the filter screen can no longer be sucked, then lift the filter screen in the direction of arrow to make it out of the clamping groove, and finally draw out the filter screen outwards to clean the filter screen.

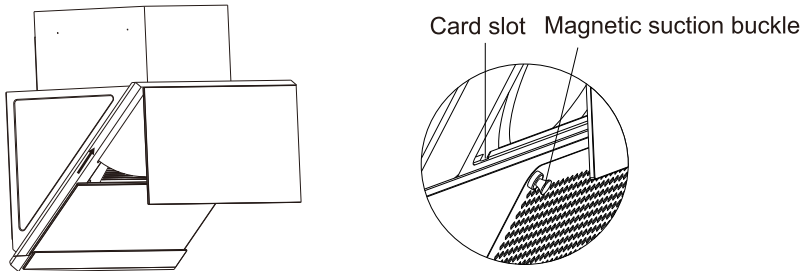

## Removal of the whole range hood

1. After the air deflector is powered on and closed, unplug the power plug.
2. Unscrew the screws on the rear plate, remove the rear plate, unscrew 6 screws at the air outlet of the air duct, and take out the air duct combination;
3. Unscrew the 4 screws on the retaining ring, then unscrew the cap clockwise and take out the impeller vertically;
4. Remove the lamp according to the "lamp disassembly" step;
5. Remove the switch combination according to the "switch disassembly" step;
6. Remove the filter screen according to the "filter screen disassembly" step;

The installation procedure is the reverse of the removal procedure.

(When installing the impeller, please apply some lubricating oil to the shaft hole of the impeller.)

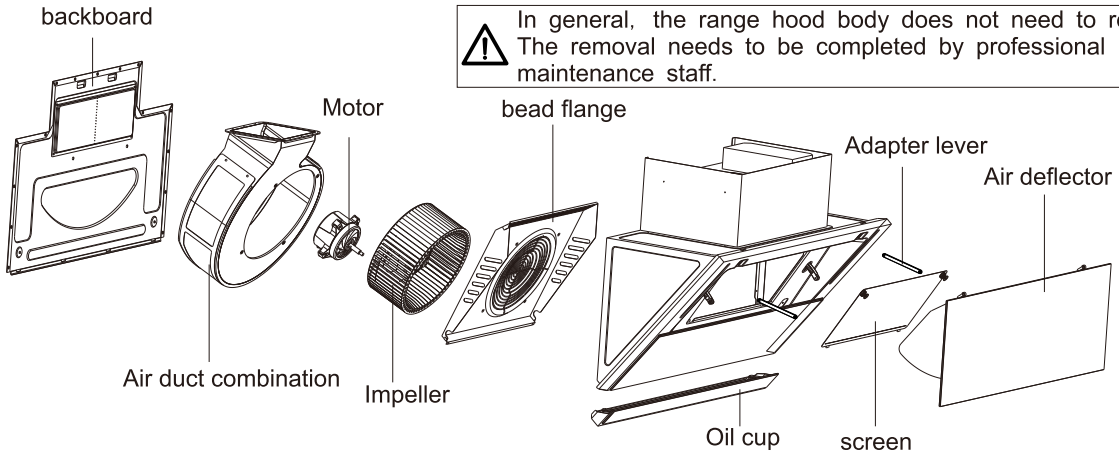

## Circuit Diagram

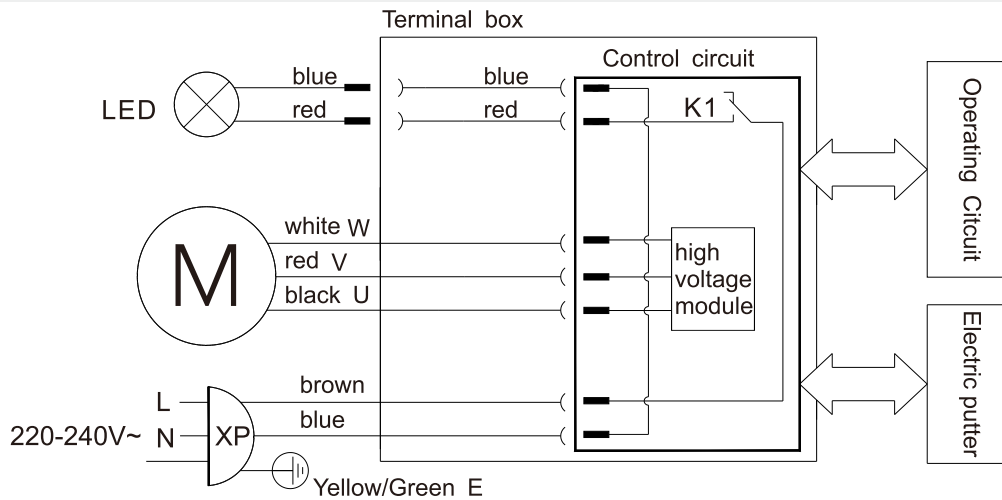

## Troubleshooting of General faults

Fault	Cause	Solution	 Warning
No response after pressing any icon (e. g. the impeller does not rotate, or the light is off)	The power plug is not connected properly or there is power failure	Plug in the power plug	When connecting or replacing the plug, please unplug the power plug.
Pressing the lighting icon, the headlamp is not lit	The light is damaged or poorly connected	Replace the light or plug in the plug	
Induced current exists on the hood body may paralyze hands	The power socket is not grounded well	Use single-phase three-pole socket and well grounded	
Abnormal sound during impeller running	The impeller is loose, and the cap is not tightened	Tighten the cap	
No oil in the oil cup after a period of time	The hood body is tilt	Adjust the body to the horizontal state	
After pressing the airflow key and during the opening of the smoke deflector, there are some beeps or the smoke deflector cannot open at al.	The driving circuit of the electronic push rod or the push rod itself malfunctions, or the wire of the push rod is in poor contact.	Contact professional maintenance personnel	

# 目 录

安全注意事项.....	1
重要信息.....	4
产品简介.....	5
装箱单.....	5
安装说明.....	6
使用说明.....	8
维护与保养.....	10
部件拆卸.....	10
线路图.....	12
一般故障的排除.....	12

## 亲爱的用户

承蒙您的厚爱，购买了老板吸油烟机，借此机会，向您表示深深的谢意！

在使用本产品前，请您仔细阅读本说明书，并妥善保管，以备将来参考。



\*本说明书中的图片为示意图，仅供参考，若图片与实物不符，以实物为准。本公司产品外观结构不断改进，对于产品改进所引起的内容更改，恕不另行通知。

## 安全注意事项

为了避免给使用者及其他人员造成危害或者财产损失，特作如下区分及标志。

以下均为有关安全的重要事项，敬请严格遵守，并在充分理解内容的基础上正确使用。







### 根据危害、损害程度进行的内容区分

 <b>危险</b>	若忽视这一标志，并进行错误操作，极有可能导致人员危险、重伤或引起火灾。
 <b>警告</b>	若忽视这一标志，并进行错误操作，有可能导致人员危险、重伤或引起火灾。
 <b>注意</b>	若忽视这一标志，并进行错误操作，有可能导致人员受伤或造成物品的损害。

### 注意、禁止内容的图标

 <b>禁止</b>	 <b>禁止明火</b>	 <b>禁止触摸</b>	 <b>禁止用潮湿的手操作</b>	 <b>禁止拆卸</b>	 <b>严格执行</b>	 <b>需要接地</b>	 <b>当心触电</b>	 <b>小心烫伤</b>
---	--	--	---	--	--	---	--	--

 **警告** 请严格按照本说明书规定使用，由于本产品使用不当造成的任何财产损失、人身伤害，本公司不承担责任。

 <b>危险</b>	
 <b>禁止</b>	请不要让无人监护的儿童及体弱者单独使用吸油烟机，否则有可能导致触电或其他意外伤害。
 <b>禁止</b>	严禁电机、开关、接插件等电器部件沾水；禁止用水冲洗吸油烟机。吸油烟机被水淋湿后，请不要使用；如果使用会导致漏电、触电等事故。
 <b>禁止</b>	请不要对电源线进行改制、拉伸、结扣以及施加重物、挤压等，否则易导致电源线破损而发生触电和火灾事故。
 <b>禁止</b>	禁止私自改动吸油烟机内部布线，否则有可能会发生异常动作导致人体受伤；修理不妥还可能发生触电、火灾等危险。
 <b>禁止用潮湿的手操作</b>	请不要用潮湿的手触摸电源插头、电器部件以及操作电源开关，否则易发生触电事故。



## 危险



严格执行

在清洗吸油烟机、提供安装或维修服务之前，必须切断电源，以免触电。



严格执行

油锅着火时，请立即关闭吸油烟机（吸油烟机的运行会助燃火势），采用有效的灭火方法灭火。例如，用金属的盖子将明火盖住，立即关闭燃气总阀门，并使易燃物远离明火。



严格执行

出现异常现象时，将电源开关按到停止状态，拔下电源插头或者切断总电源，马上与本公司当地售后服务中心联系。异常状态下连续运转易发生触电、火灾等危险。

## 警告



禁止拆卸

非专业人员请勿拆卸、安装及维修吸油烟机。



禁止

炉火在不使用时应及时熄灭，禁止炉火直接烘烤吸油烟机。禁止在吸油烟机下直接烧烤食物，以免损坏吸油烟机及发生意外。



禁止触摸

请勿触摸已经开启或者刚关闭不久的灯泡，以免烫伤。



严格执行

为确保安全和安装顺利，请使用随机附件进行安装（特别是膨胀管和木螺钉，必须使用随机附件，否则吸油烟机有掉下来的危险）；安装金属膨胀管时，管径与孔径的配合必须紧密，严禁钻孔过大，以免膨胀管松动，造成吸油烟机意外跌落。



严格执行

吸油烟机应使用专用电源插座，并且专用电源插座可靠接地；因电源线中途连接、使用延长线以及多口配线器时易发生触电、插头插座发热以及火灾。请确保由专业的电工来进行，并且要严格按照所有适用的国家和地方的电力法规；在接线以前，请先关闭电源并采取合理措施防止电源开关自动闭合。



严格执行

如果电源软线损坏，为了避免危险，必须由制造商、其维修部或类似部门的专业人员更换。



严格执行

遵照加热设备厂家的安全指南，同时要遵照消防等管理部门颁布的安全标准进行。



严格执行







当吸油烟机与燃烧燃气或其它燃料的炉灶同时使用时，房间必须通风良好。









严格执行

本产品仅供家庭日常使用，请不要在特殊环境中使用（例如：室外）；也不能用来排出有危险的或者容易爆炸的物质或者气体。产品在安装前应安放在干燥、通风、周围无腐蚀性及有害气体的环境中。

## 警告

-  **严格执行** 吸油烟机的安装以及电路设置必须要由有经验的专业人员进行，非专业人员请勿安装。在安装时要遵守所有相关的法规、标准，包括与火灾有关的说明。用户自行安装易发生触电、脱落、起火等危险。
-  **严格执行** 出风管必须确保接到室外。为了避免火灾的发生并保持空气清新，请将废气排到室外。请不要将废气排到墙内、阁楼或车库中。
-  **严格执行** 如果不按说明书规定的方法清洗，吸油烟机有起火的危险。
-  **严格执行** 请养成外出、就寝或使用后及时关闭灶具开关按钮及燃气总阀门，定期更换、检查煤气管道的习惯，煤气泄漏报警装置不能完全避免煤气泄漏事故。
-  **严格执行** 器具不打算由存在肢体、感官或精神能力缺陷或缺少使用经验和知识的人（包括儿童）使用，除非有负责他们安全的人对他们进行与器具使用有关的监督或指导。应照看好儿童，确保他们不玩耍本器具。
-  **严格执行** 灶台上烹饪容器的支承面与吸油烟机最低部位的最小距离。如果吸油烟机安装在燃气器具上方，该距离应至少为650mm。如果燃气灶台安装说明规定了更大的安装距离，则对此应予以考虑。

## 注意

-  **禁止** 吸油烟机排出的气体不应排到用于排出燃烧燃气或其它燃料的烟雾使用的热烟道中。
-  **严格执行** 在移动吸油烟机进行安装、清洁或者修理前，务必切断电源，以免触电；在进行安装、清洁或修理时，应佩戴防护手套，以防被吸油烟机内金属锐边伤手。
-  **严格执行** 吸油烟机使用的环境温度不能超过40°C。
-  **严格执行** 由于本吸油烟机的安装程序比较复杂，且重量较重，因此最好由专业安装维修人员按照说明书进行安装。
-  **严格执行** 当进行切割或者在墙壁房顶上或者天花板上钻孔时，请注意不要损坏电线以及其它隐藏设备。
-  **严格执行** 在密封性良好的建筑物中使用吸油烟机时，应保证有一空气入口，或将门稍打开一些，保证空气流通。

## 注意



当油杯内的积油超过三分之二或即将到达刻度线时，请及时清理，防止溢出。油杯中所收集的废油请勿食用。



安装吸油烟机的墙壁要有足够的支撑强度，对于中空墙壁，中空板实心层的厚度必须大于30mm以上，对于混凝土墙壁可直接打安装孔。整机必须牢固安装在墙壁上。



当使用烹饪器具时，易触及部件可能会发烫。



处置：请勿将本产品作为未分类的城市垃圾处置。需要单独收集这些废物进行特殊处理。本产品不得与生活垃圾一起处理。本产品必须在授权的地方处理，以回收电气和电子设备。通过收集和回收废物，有助于节约自然资源，并确保产品以环保和健康的方式处理。

## 重要信息

### 吸油烟机的包装

请以环保的态度处置这些包装材料，以保持一个良好的环境。

请勿让儿童玩耍塑料薄膜和包装箱，这可能会产生窒息事故，所以请让包装材料远离儿童，包装材料不是玩具。

### 使用吸油烟机前

该油烟机的排烟方式是外排式。

在您着手安装和使用本产品前，请充分阅读此说明书及随机附带的各个文件，并严格遵守，必要时请同时阅读你所购买的灶具使用说明书，并将他们妥善保存好，以备将来参考。

如发现吸油烟机有明显的损坏，请勿通电，并立即与当地的经销商或服务中心联系。

该使用说明书适用于不同型号的吸油烟机，因此您可能会发现与您的吸油烟机不同的特点描述。

## 产品简介

### 技术参数

型号	CXW-260-A675S	整机额定输入功率	262W
电源	220-240V~ 50-60Hz	主电机额定输入功率	260W
标称风压	500Pa	外形尺寸 (长×宽×高)	(895×410×668)mm
最大静压	1000Pa	主机净重	29.8kg
噪声	50dB(A)		

注：1. 性能测试均为230V~ 50Hz电源环境下测试结果，噪声测试标准依据IEC 60704。

2. 表中标称风压、最大静压的明示值与实测值误差小于10%。

3. 所示噪声值为A计权声压级。

### 机体尺寸

标注的尺寸仅供参考，其中进深尺寸含机脚。（单位：mm）

注意：橱柜内包尺寸应大于带\*尺寸，326mm为不含主机面板的进深尺寸，配上主机面板后的进深为331mm。

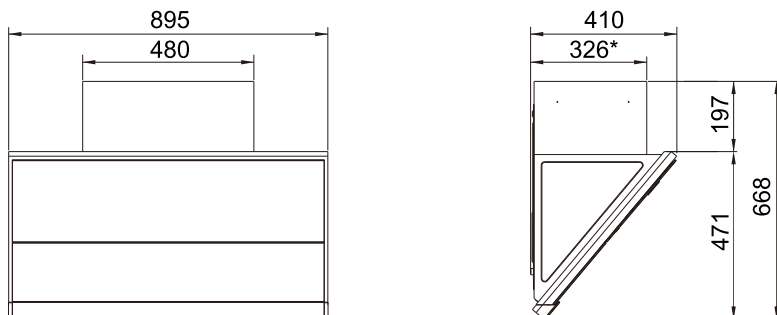

## 装箱单

开箱后请清点箱内物品

装箱单	序号	名称	数量	序号	名称	数量
	1	吸油烟机	1台	8	ST4.2×18自攻螺钉	6枚
	2	Ø185(外径)铝箔风管	1套	9	ST4.2×8自攻螺钉	6枚
	3	风管固定条		10	4×60木螺钉	4枚
	4	风管胶带		11	M6金属膨胀管	1副
	5	风管接口		12	挂脚限位块	1个
	6	使用说明书	1份	13	挂脚	1个
	7	止回阀	1套	14	塑料膨胀管	4根

## 安装说明

 烟道口径小于风管口径会影响吸烟效果，风管过长也会影响吸烟效果。

### 安装前准备

#### ●周围环境

吸油烟机应避免安装在门窗过多的地方，形成太大空气对流，而影响其除油排烟效果。

#### ●工具准备

安装吸油烟机应准备以下工具：1. 冲击电钻（带钻头） 2. 扳手 3. 螺丝刀 4. 尺

### 注意事项

●吸油烟机的安装及电路设置必须由有经验的专业人员进行，只有经过专业培训的，并具有安装资质的人员，才能对吸油烟机进行安装，非专业人员请勿安装、拆卸及维修吸油烟机。

●安装前请勿接通吸油烟机电源，以免触电。

●如果您的厨房正处于装修状态，请勿将吸油烟机暴露在外，因为建筑材料、灰尘、油漆、涂料以及它们所挥发的的气体，会使吸油烟机表面产生腐蚀和失去光泽。因此建议您在装修完毕后再安装吸油烟机。

●如果在安装吸油烟机前，需要移动燃气灶，则在移动燃气灶前，请先关闭燃气总阀门。

●请勿将吸油烟机安装在木质等易燃物的墙面上，安装吸油烟机的墙面应为有足够强度的不可燃物，且表面平直。

●吸油烟机可能有非常锋利的边，在移动吸油烟机进行安装、清洁或修理时，请佩戴防护手套。

●在墙壁或天花板等上面钻孔时，应避开墙内埋设的电线及其它隐藏设备，以免引起触电及火灾。

●吸油烟机不要装得太高，也不要受外界气流干扰，以免降低吸烟效果。

●制作橱柜时，请给机体留下装取空间，以利维护保养与检修。

●装机时，请使机体保持水平。

●请使用单相带接地插座，并良好接地（自来水管接地不可靠，煤气管道接地有引发火灾与爆炸的危险）。

●为保证安全和安装顺利，请使用随机附件进行安装，否则吸油烟机可能会有掉下来的危险。

●如电源软线损坏，为了避免危险，必须由制造商、其维修部或类似部门的专业人员更换。请不要对电源线进行改制、拉伸、结扣以及施加重物、挤压等，否则易导致电源线破损而发生触电和火灾等事故。

●安装完毕后，请先对吸油烟机表面进行清洁，然后接通电源，进行试运行操作。

## 安装

注：以下示意图的所有数据单位均以mm表示。

●确定位置：橱柜预留尺寸如图1，吊顶钻孔尺寸如图2，插座位置建议安装在吊顶上方。

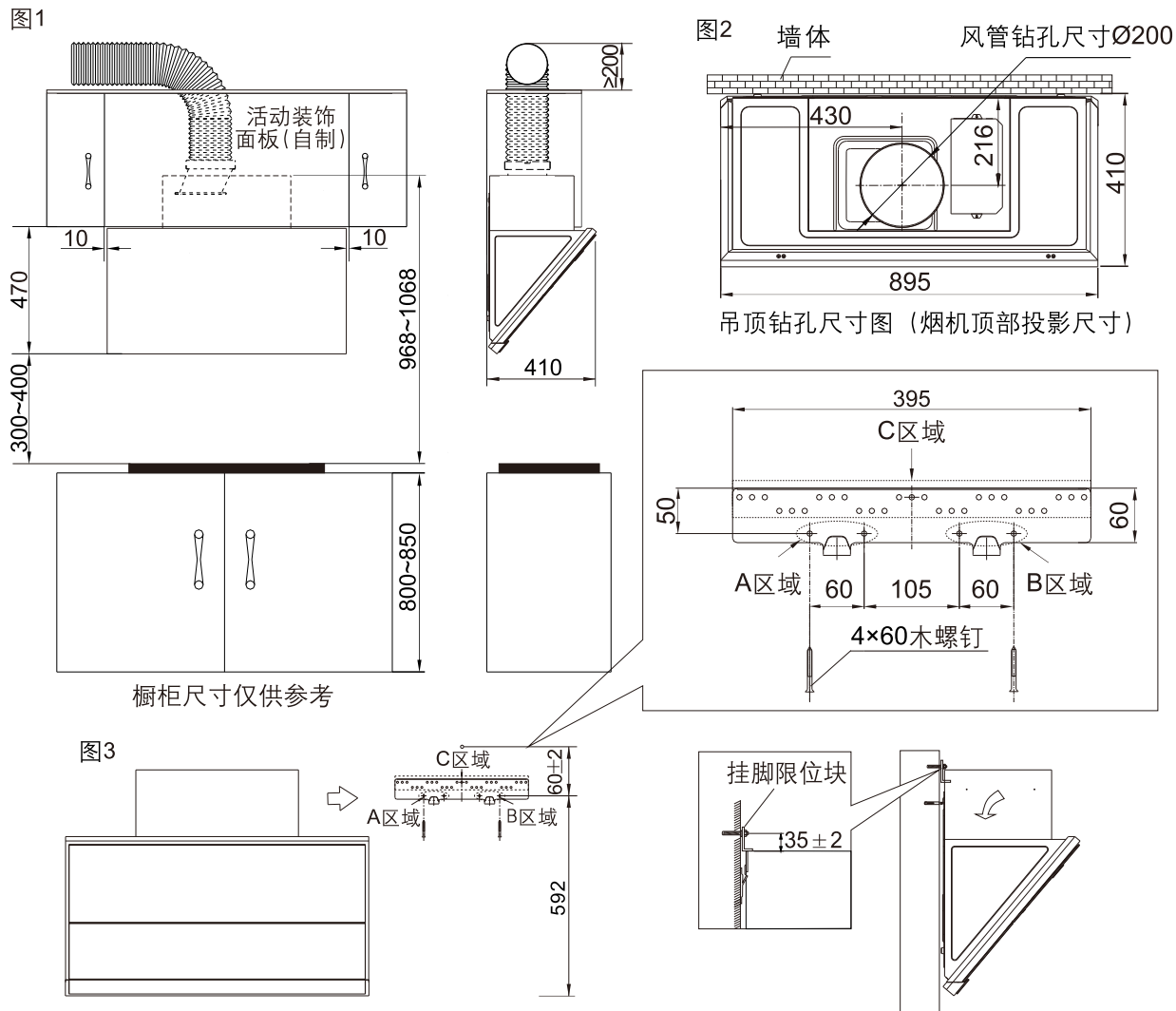

●安装挂脚：按照挂脚的尺寸在墙壁的相应位置上，用直径为10mm的钻头钻深度为60mm-70mm的四个孔（不可过大），将膨胀管压入孔内，再用随机配备的4枚4×60mm的木螺钉将挂脚可靠固定。在距离四孔高度60mm处，钻出一个直径为10mm（不可过大），深度为50mm-55mm的孔，将M6金属膨胀管塞入孔内。（如图3）

注意：1、图上A、B区域必须分别固定螺钉（每个区域至少一颗）；

2、如为木质房，C区域对应木柱部分必须固定螺钉（至少一颗）。

●安装机体：先将止回阀如图5所示固定，再按照图3所示将机体后部的挂孔对准挂脚的挂钩按压滑入，用手晃动机体看是否挂牢。待机体安装到位后，在M6金属膨胀管上装入挂脚限位块、垫片，旋紧螺母（防止机体在外力作用下意外脱钩）。

## 安装铝箔风管

### ● 铝箔风管钻孔位置（公共烟道不需要钻孔）

- 铝箔风管与炉台正对窗户之安装：拆下一方玻璃，安装一块有排风孔的胶合板，或直接在玻璃上开洞。
- 炉台不临近窗户时：选择与炉台最近且可通室外的窗户，装设铝箔风管，穿窗而出；或选择与炉台最近且可通室外的墙壁打洞，装设铝箔风管，穿墙而出。
- 钻穿墙洞：先量好铝箔风管对墙位置，在壁面上画好钻孔范围（即比铝箔风管外径略大的圆形），再使用长钻头钻穿墙壁。钻孔时应注意墙壁结构和材料，切勿破坏墙洞以外的壁面。

### ● 连接铝箔风管

先将铝箔风管无风管固定条一端套上风管接口用胶带贴住，并将风管拉直后与公共烟道接口进行连接（若无公共烟道的，请将风管拉直接至室外）。当公共烟道接口或墙孔大于铝箔风管时可以直接连接，当小于风管时，可选购风管接口。风管接口小端有外径140mm、150mm、160mm、170mm以及180mm五种规格，可根据实际情况，将小于公共烟道接口或墙孔的多余部分剪去。

然后，将铝箔风管带有风管固定条的一端插入止回阀接口外圈上，并用风管胶带密封。最后，把止回阀接口的四个卡扣放入止回阀的四个卡槽中，顺时针旋转即可将风管固定在止回阀上。

图4

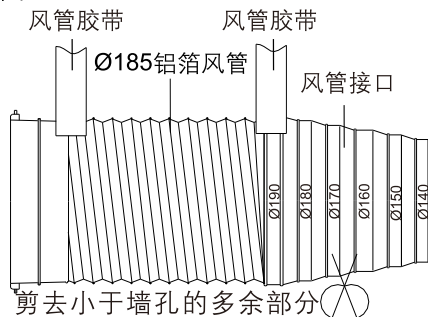

注意：安装时请将铝箔风管拉直，以免铝箔风管在半拉伸状态时产生噪音，多余部分可用钢丝钳剪去。

图5

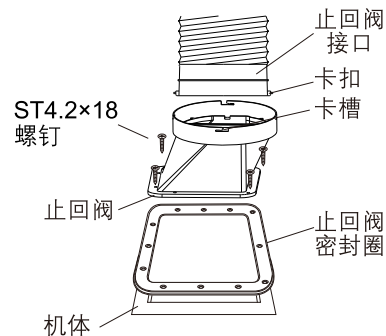

排风墙孔直径应与风管直径相近，不应太小，否则会造成排烟不畅、噪音升高、风量降低等情况。出风管与墙孔或公共烟道接口连接处必须严格进行密封，确保出风管与止回阀或公共烟道接口连接牢固，必须保证公共烟道接口处的叶片开合灵活。

## 使用说明

### 开关控制面板

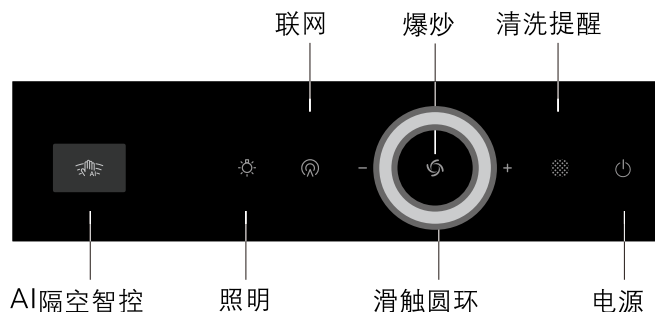

接通电源，蜂鸣器鸣响，所有指示灯亮，数秒后熄灭，提示进入通电状态。

 <p>电源</p>	<p>按下电源键，进入开机状态，电源键图标亮。</p> <ol style="list-style-type: none"><li>1. 如果电源开启时风机正在工作，按电源键，电源键图标将闪烁，烟机进入延时工作状态，1分钟后关闭烟机。电源键闪烁时，再按下电源键，则直接关闭烟机。</li><li>2. 在开机状态下，如3分钟内无任何功能运行，则自动关机。</li></ol>
 <p>滑触圆环</p>	<ol style="list-style-type: none"><li>1. 顺时针滑动或点击圆环右半边可调大风量，最大到爆炒档；</li><li>2. 逆时针滑动或点击圆环左半边可调小风量，最小到关闭；</li><li>3. 圆环显示：爆炒风量时显示整圈蓝色呼吸； 强档风量时显示整圈蓝色； 弱档风量时显示整圈白色。</li></ol>
 <p>爆炒</p>	<ol style="list-style-type: none"><li>1. 按爆炒键，爆炒图标长亮，圆环蓝色全亮并显示呼吸效果，进入爆炒状态。3分钟后自动切换到强档，圆环停止呼吸，转变为蓝色长亮，爆炒图标熄灭；</li><li>2. 爆炒状态下再按一次该键，图标及圆环均熄灭，风机停止工作。</li></ol>
 <p>清洗提醒</p>	<ol style="list-style-type: none"><li>1. 当烟机累计运行60小时后，清洗提醒图标闪烁，提醒用户清理油网；</li><li>2. 长按清洗提醒键，该图标长亮，进入清洗模式（风机停转、照明灯及导风板打开，除清洗提醒键和照明键外，其余按键无效）；</li><li>3. 用户须自行清洗油网，清理完毕后长按此键，清洗提醒图标熄灭，退出清洗模式，累计时间清零。</li></ol>
 <p>照明</p>	<p>开机或者关机状态按照明键，可开启或关闭照明灯。开启或关闭时照明灯均为逐渐点亮或逐渐关闭。</p>
 <p>AI隔空智控</p>	<ol style="list-style-type: none"><li>1. 在感应区前悬停可控制开关机并同步开关灯光，从左向右挥手控制大风量爆炒和强档切换，从右向左挥手控制小风量弱档和关闭切换；</li><li>2. 关机状态同时长按爆炒键和清洗提醒键，可将感应功能关闭或开启，同时长按爆炒键和照明键，可将手势开机自动亮灯功能关闭或开启。</li></ol>
 <p>联网</p>	<ol style="list-style-type: none"><li>1. 电源键开启状态下，长按联网键进入联网配置状态，联网图标闪烁，联网成功后，图标长亮。若3分钟未联网成功，则图标停止闪烁并熄灭；</li><li>2. 联网成功且网络正常时，开机则联网图标长亮，关机则图标熄灭。</li></ol>



## 维护与保养

### 注意事项

- 吸油烟机应视环境条件定期维护清洗，以保持机体清洁与使用效果，延长使用寿命。我们建议：产品外表面在每次烹饪后都进行擦拭。为保证油烟顺畅排出，滤网视使用情况经常清洗，洗时请小心，以免损坏。
- 请勿用强力洗涤剂，建议用中性洗涤剂清洗，并用软布擦干。如果您的吸油烟机为机械开关，应同时避免清洁剂接触各控制键。
- 不要让污渍在吸油烟机表面停留时间过长。
- 请不要使用清洁球、刷子等粗糙物对吸油烟机进行清洁，以防划伤机体表面。
- 清洁或保养吸油烟机时，请戴上防护手套，以防擦拭过程中受伤。
- 请定期检查和清理油杯。如右图双手捏住油杯，向外拉出，倒去废油。
- 吸油烟机应在烹饪前开启。
- 长期不使用时，请将电源插头拔出，但请勿用力拽拉。



## 部件拆卸

注：以下部件的安装步骤与拆卸步骤相反，为防止金属锐边伤手，请在操作时佩戴好防护手套。

**⚠** 在安装或拆卸之前，必须切断电源，以免触电。

### 灯拆卸

●长按清洗提醒键，使导风板打开，然后拔下电源插头。用一字螺丝刀插入灯与导风板缝隙内，撬出灯即可进行维修与更换。

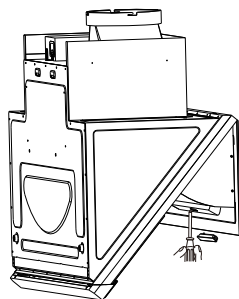

照明灯图形		照明灯信息	
		照明灯类型	长方形 LED
		最大功率	2W
		电压	12VDC
		尺寸	见照明灯图形

## 开关拆卸

- 长按清洗提醒键，使导风板打开，然后拔下电源插头。
- 先用螺丝刀拧下降噪板上的两颗螺钉，取出降噪板和降噪棉。再拧下盖板中间的一颗螺钉后，取出开关组合，拨开连接线，即可进行维修与更换。

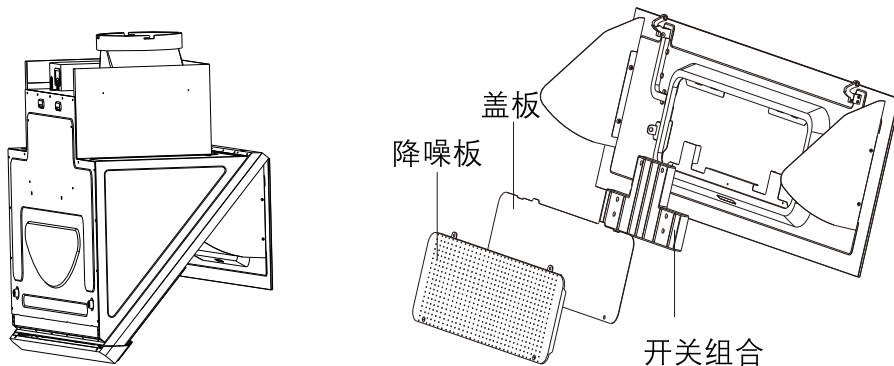

## 滤网拆卸

- 长按清洗提醒键，使导风板打开。
- 双手拿住滤网上的两个磁吸扣，稍向外用力，使滤网不再被吸住，然后按箭头方向提起滤网，使其脱离卡槽，最后向外抽出滤网，即可对滤网进行清洗。

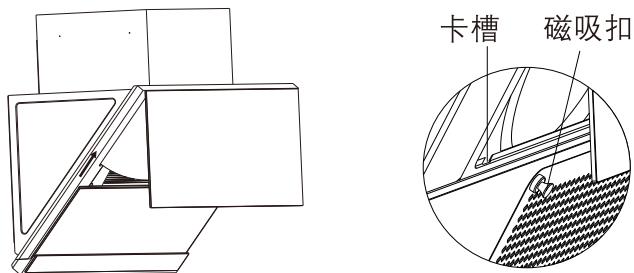

## 整机拆卸

1. 上电闭合导风板后，再拔下电源插头；
2. 拧下后板上的螺钉，取下后板，再拧下风道出风口的6颗螺钉，取出风道组合；
3. 拧下挡圈上的4颗螺钉，再顺时针旋下盖帽，垂直取出叶轮；
4. 按《灯拆卸》步骤取下灯；
5. 按《开关拆卸》步骤取下开关组合；
6. 按《滤网拆卸》步骤取下滤网；

装上步骤与拆卸步骤相反。

(装上叶轮时，请在叶轮的轴孔中抹一些润滑油。)

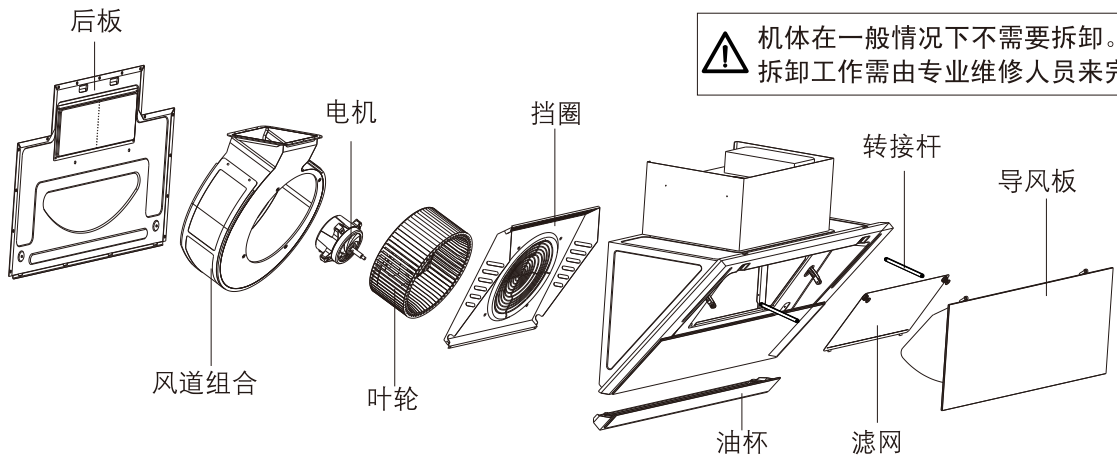

**⚠️ 警告** 机体在一般情况下不需要拆卸。  
拆卸工作需由专业维修人员来完成。

## 线路图

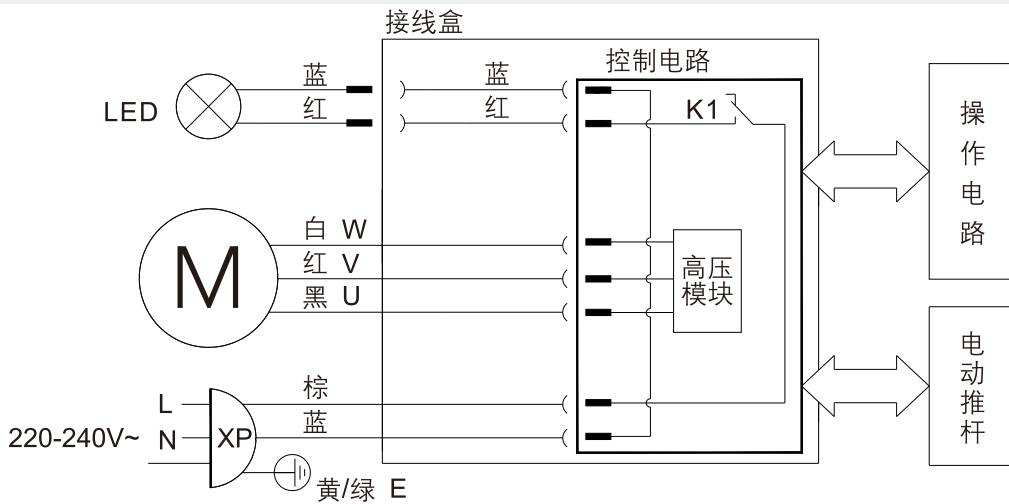

## 一般故障的排除

故障现象	故障原因	排除方法	<b>⚠️ 警告</b> 在连接插件或更换时，务必拔下电源插头。
按任何键都无反应 (如叶轮不转动、照明灯不亮)	电源插头未插好或停电	插紧电源插头	
按照明键，照明灯不亮	照明灯损坏或照明灯接触不良	更换照明灯或插紧插件	
机体表面有感应电，麻手	电源插座没有良好接地	使用单相三极插座并良好接地	
叶轮运转有异常声	叶轮松动，盖帽未旋紧	旋紧盖帽	
使用一段时间后不见油滴入油杯	机体装置未呈水平，有倾斜	调整机体至水平状态	
打开导风板过程中听到几声蜂鸣提示，或导风板完全打不开。	电动推杆驱动电路故障，或电动推杆故障，或电动推杆导线接触不良。	联系专业维修人员	

版次: A/1

出版日期: 2021年2月1日

Edition: A/1

Publication Date: February, 1, 2021

**ROBAM**