

Model: Full Electric Range
Edition: A/0
Publication Date: JUNE,10,2023

ROBAM

ROBAM



User Manual

Before operating this unit, please read the user manual completely and keep it. If the manual is lost, you can send e-mail to overseas@robam.com, request for an electronic manual.

JJZ(Y/T)-7EW10

Full Electric Range

CONTENTS

Product Overview.....	4
Safety Warnings	6
Installation	14
Operation	22
Using the Cooktop	28
Using the Oven	34
Maintenance	50
Troubleshooting.....	58

Product Overview

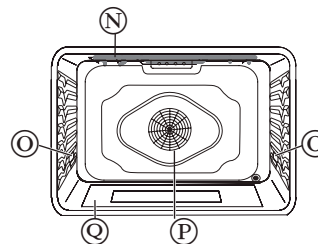
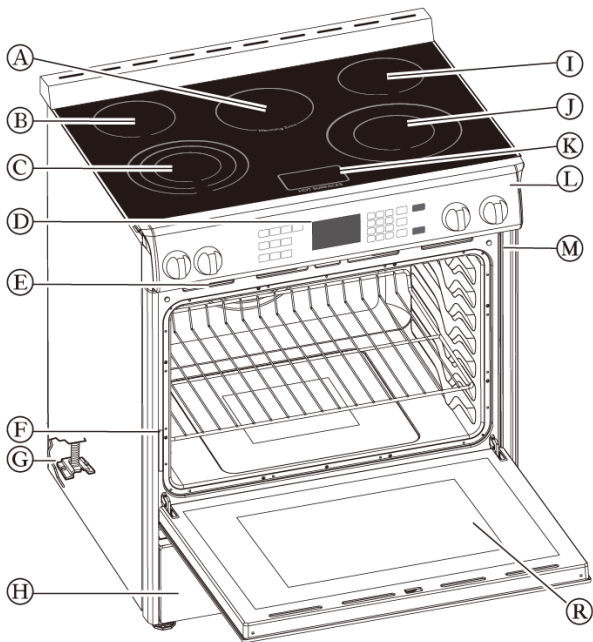

- A. Warming Zone Burner
- B. Left Rear Surface Burner
- C. Left Front Surface Burner (Triple-element)
- D. Clock/Timer
- E. Oven Vent
- F. Model and Serial Number Plate
- G. Anti-tip Bracket
- H. Storage Drawer
- I. Right Rear Surface Burner
- J. Right Front Surface Burner (Dual -element)
- K. Hot Surface Indicator Lights
- L. Control Panel
- M. Door Gasket
- N. Broil Element
- O. Oven Light
- P. Convection Fan and Element
- Q. Bottom Element (not visible)
- R. Oven Door Window

SAFETY WARNINGS

RANGE SAFETY

Your safety and the safety of others are very important.

We have provided many important safety messages in this manual and on your appliance. Always read and obey all safety messages.



This is the safety alert symbol. This symbol alerts you to potential hazards that can kill or hurt you and others. All safety messages will follow the safety alert symbol and either the word “DANGER”, “WARNING” or “CAUTION”. These words mean:

! DANGER

An imminently hazardous situation. You could be

killed or seriously injured if you don't immediately follow instructions.

! WARNING

A potentially hazardous situation which, if not avoided, could result in death or serious bodily injury.

! CAUTION

A potentially hazardous situation which, if not avoided, may result in moderate or minor injury.

All safety messages will tell you what the potential hazard

is, tell you how to reduce the chance of injury, and tell you what can happen if the instructions are not followed.

THE ANTI-TIP BRACKET

! WARNING



Tip Over Hazard

A child or adult can tip the range and be killed. Connect anti-tip bracket to rear range foot. Reconnect the anti-tip bracket, if the range is moved. See the installation instructions for details. Failure to follow these instructions can result in death or serious burns to children and adults.

Making sure the anti-tip bracket is installed:

- Slide range forward.
- Look for the anti-tip bracket securely attached to floor.
- Slide range back so rear range foot is under anti-tip bracket.

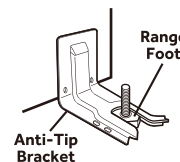

IMPORTANT SAFETY INSTRUCTIONS

WARNING: To reduce the risk of fire, electrical shock, injury to persons, or damage when using the range, follow basic precautions, including the following:

- **WARNING:** TO REDUCE THE RISK OF TIPPING THE RANGE, THE RANGE MUST BE SECURED BY PROPERLY INSTALLED ANTI-TIP DEVICES. TO CHECK IF THE DEVICES ARE INSTALLED PROPERLY, SLIDE RANGE COMPLETELY FORWARD, LOOK FOR ANTI-TIP BRACKET SECURELY ATTACHED TO THE FLOOR BEHIND THE RANGE AND SLIDE RANGE COMPLETELY BACK UNTIL THE REAR RANGE FOOT IS UNDER ANTI-TIP BRACKET.
- **WARNING:** NEVER use this appliance as a space heater to heat or warm the room. Doing so may result in carbon monoxide poisoning and overheating of the oven.
- **WARNING:** NEVER cover any slots, holes or passages in the oven bottom or cover an entire rack with materials such as aluminum foil. Doing so blocks airflow through the oven and may cause carbon monoxide poisoning. Aluminum foil linings may also trap heat, causing a fire hazard.

- **CAUTION:** Do not store items of interest to children in cabinets above a range or on the back guard of a range - children climbing on the range to reach items could be seriously injured.

- Do Not Leave Children Alone -- Children should not be left alone or unattended in area where the range is in use. They should never be allowed to sit or stand on any part of the range.
- Wear Proper Apparel -- Loose-fitting or hanging garments should never be worn while using the range.
- User Servicing -- Do not repair or replace any part of the range unless specifically recommended in the manual.
- All other servicing should be referred to a qualified technician.
- Storage in or on the Range -- Flammable materials should not be stored in an oven or near surface units. Do Not Use Water on Grease Fires - Smother fire or flame or use dry chemical or foam-type extinguisher.
- Use Only Dry Potholders -- Moist or damp potholders on hot surfaces may result in burns from steam. Do not let potholder touch hot heating elements. Do not use a towel

or other bulky cloth.

- **DO NOT TOUCH SURFACE UNITS OR AREAS NEAR UNITS** -- Surface units may be hot even though they are dark in color. Areas near surface units may become hot enough to cause burns. During and after use, do not touch, or let clothing or other flammable materials contact surface units or areas near units until they have had sufficient time to cool. Among those areas are the cooktop and surfaces facing the cooktop.
- **Never Leave Surface Units Unattended at High Heat Settings** -- Broil over causes smoking and greasy spillovers that may ignite.
- **Glazed Cooking Utensils**- Only certain types of glass, glass/ceramic, ceramic, earthenware, or other glazed utensils are suitable for range-top service without breaking due to the sudden change in temperature.
- **Utensil Handles Should Be Turned Inward and Not Extend Over Adjacent Surface Units** -- To reduce the risk of burns, ignition of flammable materials, and spillage due to unintentional contact with the utensil, the handle of a utensil should be positioned so that it is turned inward, and does not extend over adjacent surface units.
- **Clean Cooktop With Caution** -- If a wet sponge or cloth is used to wipe spills on a hot cooking area, be careful to avoid steam burn. Some cleaners can produce noxious fumes if applied to a hot surface.

- **Use Care When Opening Door** -- Let hot air or steam escape before removing or replacing food.
- **Do Not Heat Unopened Food Containers** -- Build-up of pressure may cause container to burst and result in injury.
- **Keep Oven Vent Ducts Unobstructed.**
- **Placement of Oven Racks** -- Always place oven racks in desired location while oven is cool. If rack must be moved while oven is hot, do not let potholder contact heating element in oven.
- **DO NOT TOUCH HEATING ELEMENTS OR INTERIOR SURFACES OF OVEN** -- Heating elements may be hot even though they are dark in color. Interior surfaces of an oven become hot enough to cause burns. During and after use, do not touch, or let clothing or other flammable materials contact heating elements or interior surfaces of oven until they have had sufficient time to cool. Other surfaces of oven until they have had sufficient time to cool. Other surfaces of the appliance may become hot enough to cause burns - among these surfaces are oven vent openings and surfaces near these openings, oven doors, and windows of oven doors.
- **Proper Installation** -- The range, when installed, must be electrically grounded in accordance with local codes or, in the absence of local codes, with the National Electrical Code, ANSI/NFPA 70. In Canada, the range must be electrically grounded in accordance with Canadian Electrical Code.

Be sure the range is properly installed and grounded by a qualified technician.

- Disconnect the electrical supply before servicing the appliance.
- Injuries may result from the misuse of appliance doors or drawers such as stepping, leaning, or sitting on the doors or drawers.
- Maintenance -- Keep range area clear and free from combustible materials, gasoline, and other flammable vapors and liquids.

For units with ventiating hood -

- Clean Ventilating Hoods Frequently -- Grease should not be allowed to accumulate on hood or filter.
- When flambe cooking under the vent hood, turn the fan on.

READ AND SAVE THESE INSTRUCTIONS

INSTALLATION

TOOLS AND PARTS

Gather the required tools and parts before starting installation. Read and follow the instructions provided with any tools listed here.

TOOLS NEEDED

PARTS SUPPLIED

Check that all parts are included.

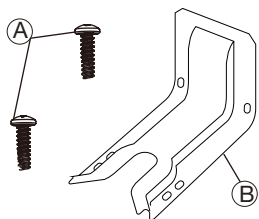

(A) 16 x 15/8" Screws (2)

(B) Anti-tip Bracket

NOTE: The Anti-tip bracket must be securely mounted to the subfloor. The thickness of flooring may require longer screws to anchor bracket to subfloor. Longer screws are available from your local hardware store.

LOCATION REQUIREMENTS

VENTILATION

IMPORTANT : Observe all governing codes and ordinances.

- It is the installer's responsibility to comply with installation clearances, if specified on the model/serial rating plate. The model/serial rating plate is located in the left-hand side of the oven frame. Open oven door to view label. See label on back panel of range for additional element and oven power rating.

TEMPERATURE

IMPORTANT: Some cabinet and building materials are not designed to withstand the heat produced by the oven for baking and self-cleaning. Check with your builder or cabinet supplier to make sure that the materials used will not discolor, delaminate or sustain other damage.

- Contact a qualified floor covering installer to check that the floor can withstand at least 200 °F (93 °C)
- Use an insulated pad or 1/4" (0.64cm) plywood under range if installing range over carpeting.

GENERAL

- The range should be located for convenient use in the kitchen.
- Recessed installations must provide complete enclosure of the sides and rear of the range.
- To eliminate the risk of burns or fire by reaching over heated surface units, cabinet storage space located above the surface units should be avoided. If cabinet storage is to be provided, the risk can be reduced by installing a range hood or microwave hood combination that projects horizontally a minimum of 5" (12.7cm) beyond of the cabinets.
- All openings in the wall or floor where range is to be installed must be sealed.
- Do not seal the range to the side cabinets.
- Grounded electrical supply is required. See "Electrical Requirements"

DIMENSIONS

Product

Opening dimensions shown are for 25" (64cm) countertop depth, 24" (61cm) base cabinet depth and 36" (91.4cm) countertop height.

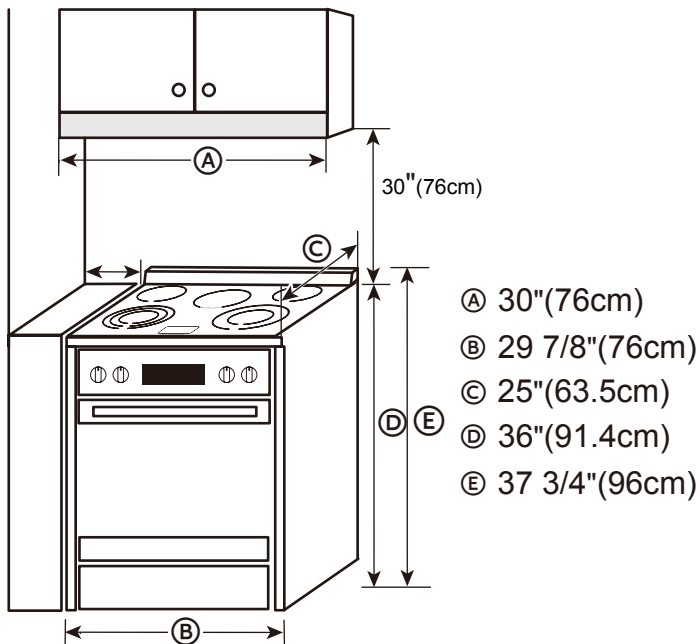

NOTE: Range can be raised approximately 1" (2.5cm) by adjusting the leveling legs. Front of door and drawer may extend farther forward depending on styling.

POWER SUPPLY

IMPORTANT: To connect to an outlet in the wall, the electrical outlet must be recessed. If the electrical outlet is in the floor, it can be either recessed or surface mounted.

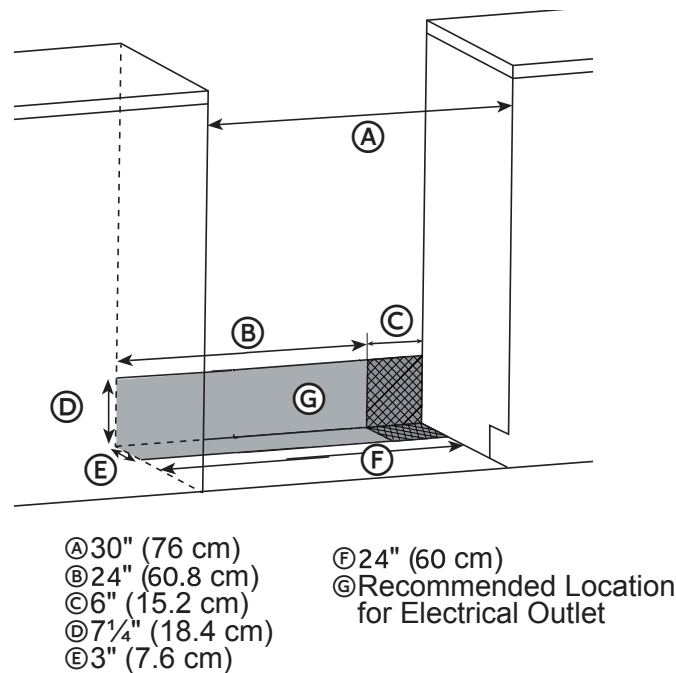

ELECTRICAL REQUIREMENTS- CANADA ONLY



WARNING

Electrical Shock Hazard

Disconnect power before servicing.

Plug into a grounded outlet.

Do not use an extension cord.

Failure to do so can result in death, fire, or electrical shock.



If codes permit and a separate ground wire is used, it is recommended that a qualified electrical installer determine that the ground path is adequate and wire gauge are in accordance with local codes.

Be sure that the electrical connection and wire size are adequate and in conformance with CSA Standard C22.1, Canadian Electrical Code, Part 1- latest edition, and all local codes and ordinances.

A copy of the above code standards can be obtained from:

Canadian Standards
Association 178 Rexdale Blvd.
Toronto, ON M9W 1R3
CANADA.

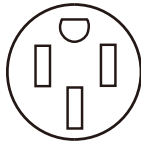

- Check with a qualified electrical installer if you are not sure the range is properly grounded.
- This range is equipped with a CSA International Certified Power Cord intended to be plugged into a standard 14-50R wall receptacle. Be sure the wall receptacle is within of range's final location.
- Do not use an extension cord.

INSTALLATION INSTRUCTION

IMPORTANT: This appliance shall be installed only by authorized persons and in accordance with the manufacture's installation instructions, local ga fitting regulations, municipal building codes, electrical wiring regulations, local water supply regulations.

STEP 1 - UNPACK RANGE

WARNING

Excessive Weight Hazard

Use two or more people to move and install range.
Failure to do so can result in back or other injury.

1. Remove shipping materials, tape and film from the range. Keep cardboard bottom under range. Do not dispose of anything until the installation is complete.
2. Remove oven racks and parts package from oven and shipping materials.
3. To remove cardboard bottom, first take four cardboard corners from the carton.
Stack one cardboard corner on top of another. Repeat with the other two corners. Place them lengthwise on the floor behind the range to support the range when it is laid on its back.
4. Using two or more people, firmly grasp the range and gently lay it on its back on the cardboard corners.
5. Remove cardboard bottom.

NOTES:

- The leveling legs can be adjusted while the range is on its back.

- To place range back up into a standing position, put a sheet of cardboard or hardboard on the floor in front of range to protect the flooring. Using two or more people, stand range back up onto the cardboard or hardboard.

STEP 2 - INSTALL ANTI-TIP BRACKET

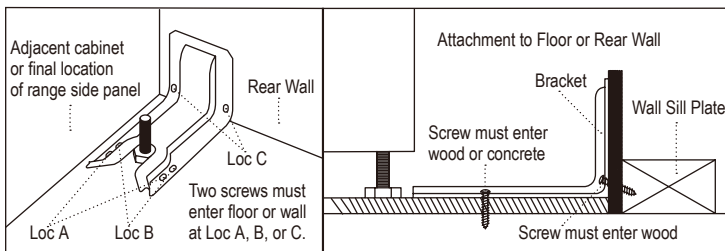

NOTE: The anti-tip bracket must be PROPERLY INSTALLED and the rear leveling leg must be FULLY ENGAGED into the bracket to the prevent the range from tipping. NEVER remove the leveling legs. This will prevent the range from being secured to the ANTI-TIP bracket properly.

STEP 3 - MAKE ELECTRICAL CONNECTION

Plug into a standard 14-50R grounded wall receptacle.

STEP 4 - INSTALL RANGE

IMPORTANT: If the range is moved to adjust the levelling legs, make sure when you move the range back into its final location that the anti-tip bracket is engaged.

STEP 5 - COMPLETE INSTALLATION

1. Reconnect power at the circuit breaker or fuse box.
 2. Turn on each element to check that it is heating correctly.
 3. Turn on the oven to check that it is heating correctly.
NOTE: When the range has been on for 5 minutes, check for heat. If range is cold, turn off the range and contact a qualified technician.
 4. Check that the indicator lights on the control panel, and the interior oven lights illuminate correctly.
- If the range does not operate correctly, check the following:
- Household fuse is intact and tight; or circuit breaker has not tripped.
 - Range is plugged into a grounded outlet
 - Electrical supply is connected.
- Contact a qualified electrician to verify the electrical supply.

WHAT'S INCLUDED



Oven Racks x2



Air Fry Basket x1



Meat Probe x1

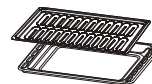

Broiler Pan Rack x1
Broiler Pan x1



Telescoping Oven Rack x1

OPERATION

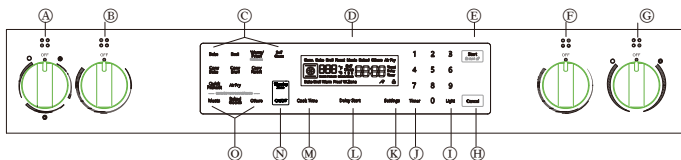

- | | |
|--|---------------------------------|
| A. Front Left Burner | H. Cancel |
| B. Rear Left Burner | I. Light |
| C. Oven Modes | J. Timer |
| D. Display | K. Setting |
| E. Start/Control Lock
(hold 3 seconds) | L. Delay Start |
| F. Rear Right Burner | M. Cook Time |
| G. Front Right Burner | N. Warming Zone |
| | O. Convection Conversion |

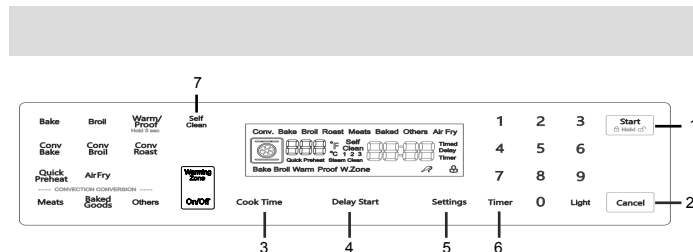

KEY AND ICON DEFINITIONS

- 1) Start:
Start button, start operation or start Setting to take effect.
- 2) Cancel:
Cancel button to cancel the current operation.
- 3) Cooktime:
Bake time button, used to set the bake time.
- 4) Delay Start:
The appointment time button is used to set the start time.
- 5) Settings:
Select system settings. Press repeatedly to display different settings.
- 6) Timer:
Timer symbol - This symbol is displayed on the LCD after the timer function is set



Pin symbol - this symbol appears on the display screen when the system detects a thermometer pin.



Child lock symbol - the same as locking all keys, the child lock is set, the display will appear this symbol

Oven

Operation Mode		Default temperature (°F)	Adjustable range	Preheat phase
Bake		350	170-550	✓
Broil		Hi	Hi/Lo	✗
Proof (Press for 3 seconds in Warm Mode temp)		100	80-120	✗
Warm		140	140-210	✗
Conv	Convect Bake	325	170-500	✓
	Convect Broil	450	170-550	✗
	Convect Roast	325	170-550	✓
	Easy Convect	1. Meats	350	170-500
2. Baked goods				
3. Others				
Air Fry		420	300-450	✓
Warming Zone		/	/	✗
Self Clean		No	Core up to 806°F(430°C)	✗
Steam Clean		/	/	✗

NOTE: The preheating stage indicates whether real-time display of temperature is required.

There is a preheating stage: When the actual oven core temperature is less than 170 °F, the interface displays LO.

When the actual core temperature of the oven is greater than or greater than or equal to 170, the interface displays the temperature in real time.

When the actual oven core temperature reaches the set value, the interface always displays the set temperature value.

Non-preheating stage: the set temperature value is always displayed on the heating interface of the oven from the beginning.

FUNCTIONS

To access the setting function, press the Setting button on the switch panel. There are seven Settings. You can press the Settings button repeatedly to select the settings.

Parameter that can be set	Touch Settings repeatedly	Congurable content	Default
Clock	Touch once	Set clock	12:00 PM
Temp unit	Touch twice	Press“1”: Degree °F /°C	°F
Sound	Touch three times	Press“1”: On/Off	On
Calibration	Touch four times	Press“1”to change mode Press“3” to increase Press“6” to decrease	00°F (-30°F~30°F)
Demo mode	Touch five times	Press“1”: On/Off	Off
12/24 H	Touch six times	Press“1”: 12 H/24 H	12 H
Sabbath	Touch seven times	Press“1”: On/Off	Off

REMINDER

Setting Clock:

Touch the “Setting’ once to enter the colock setting. By default, the current time is 12:00. At this time, youcan enter the required time by touching number key, then press the “Start’ key to save current data and exit.

Setting Demo Mode:

This parameter is set to facilitate users to enter the demonstration mode and perform operations on the interface in any mode. However, heating components such as the electric heat pipe are not enabled. The default

value is OFF. Press the Settings key 5 times to enter the demo, then press the number key “1” to switch. Touch the Start key to confirm exit.

CHILD LOCK

- 1). When the oven is on standby or enters the working state, touch the "Start" button and hold it for 3 seconds, the control panel will be locked, except the "Start" button, other keys are invalid . The child lock icon will flash and an invalid tone is heard concurrently when touching other keys. If there is no unlock after 3 seconds, it will return to the standby or current operating state. Touch the "Start" button and hold it for 3 seconds, the child lock will be released and the symbol will disappear.
- 3). The child lock function is only effective in the interface of standby and mode operation, and not in other Settings interface.

ALARM

- 1). Touch the “Timer” button to enter the alarm Settings as shown below: The maximum allowable setting time of the alarm clock is 12 hours with a countdown and display mode (hour : minute)/(minute : second), if the set ting time is left less than 1 hour, then the system shown in the form of (minute: second, otherwise in the form of (hour: minute). After the alarm is set, the alarm countdown starts. In standby mode, the alarm time is displayed on the screen. In the running state, only the alarm symbol is displayed, no alarm time. At the end of the countdown, the buzzer rings and the alarm symbol blinks with “00:00” at the same time. At this time, you can touch any key to cancel the alarm. If there is no touch, the alarm will stop after one minute, and the alarm icon and “00:00” will stop blinking and disappear.
- 2). Alarm cancellation: just touch the “Timer” button.

ERROR ALARM

Abnormal Temperature sensor: “Err1”.
In any state, if the temperature sensor is open or short, the oven will give an alarm and display “Err1”. In this case, cancel will be performed.

USING THE COOKTOP

The ceramic cooking area will glow red when a heating element is on. Some parts of the cooktop may not glow red when an element is on. This is normal. The cooking area cycles off and on, even when set to HI, to keep the cooktop glass from overheating. It is normal for the surface of ceramic glass to appear to change color when surface cooking areas are hot. As the glass cools, it will return to its original color.

IMPORTANT: To avoid permanent damage from pitting or scratching, and to keep the cooktop surface in good condition, clean the cooktop after each use. Ceramic glass cooktop cleaner and a cooktop scraper are also recommended for stubborn soils. Do not use abrasive cleaners, cleaning pads or harsh chemicals for cleaning. All of the items to clean and condition your ceramic glass cooktop are available at most grocery stores. See the “Range Care” section for additional information.

- Make sure the bottoms of pots and pans are clean and dry before using them. Residue and water can leave deposits when heated.
- Avoid storing jars or cans above the cooktop. Dropping a heavy or hard object onto the cooktop could crack the cooktop.
- To avoid damage to the cooktop, do not leave a hot lid on the cooktop.

As the cooktop cools, air can become trapped between the lid and the cooktop, and the ceramic glass could break when the lid is removed.

- For foods containing sugar in any form, clean up all spills as soon as possible. If sugary spills are allowed to cool down, they can adhere to the cooktop and can cause pitting and permanent marks.
- Allow the cooktop to cool down slightly.
- While wearing oven mitts, remove the spill using a scraper while the surface is still warm.
- To avoid scratches, do not slide cookware or bakeware across the cooktop. Aluminum or copper bottoms and rough finishes on cookware or bakeware could leave scratches or marks on the cooktop.
- Do not cook popcorn in prepackaged aluminum containers on the cooktop. They could leave aluminum marks that cannot be removed completely.
- To avoid damage to the cooktop, do not allow objects that could melt, such as plastic or aluminum foil, to touch any part of the entire cooktop.
- To avoid damage to the cooktop, do not use the cooktop as a cutting board.
- To avoid damage to the cooktop, do not cook foods directly on the cooktop.

BEFORE USE

- 1). If present, remove all packing and literature from the cooktop surface.
- 2). Clean your glass top. A thorough cleaning with a glass top cleaner is recommended. It only takes a minute and puts a clean, shiny coating on the glass top before its initial use.
- 3). Place a saucepan of water on each of the front burners and turn them on HI heat for at least 30 minutes. Turn off the front burners.
- 4). Place a saucepan of water on each of the rear burners and turn them on HI heat for at least 30 minutes. Turn off the rear burners

NOTES:

- This procedure evaporates any protective oils and humidity collected during the manufacturing process, and enables the electronic control circuits to operate properly.
- There may be a slight odor during the first several uses: this is normal and will dissipate.
- The cooking surface will hold the heat and remain hot over 20 minutes after the elements have been turned off.

HEATING ELEMENTS

NOTES:

- For fastest boiling with pots 10" (25.4 cm) and larger, use the Even-Heat™ (Triple-ring) element with all elements set to “HI.”
- For best low heat performance with pans 10" (25.4 cm) and larger, use the Dual-Size element set to “Single Lo.”
- For best melting performance with small pans, use the Even-Heat™ element.

HOT SURFACE INDICATOR LIGHT are located on the glass cooktop... The Hot Surface Indicator Lights will glow as long as any cooking area is too hot to touch, even after the surface cooking area is turned off.

DUAL-RING COOKING ELEMENT offer the flexibility to use larger cookware.

- Single-size elements can be used in the same way as a regular element.
- The dual-size combines both the single and outer element and is recommended for larger size cookware.

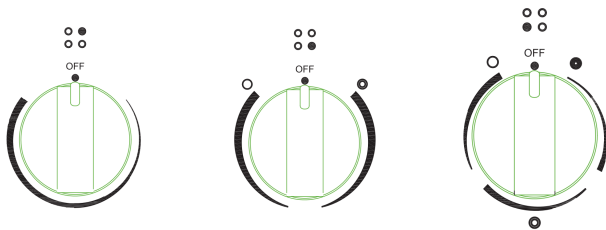

TRIPLE-RING ELEMENT offers flexibility because it features a wide range of settings.

- The High heat option can be used to boil small amounts of liquid quickly. To reduce the power setting, turn the knob clockwise.
- The Melt setting is designed for delicate foods that require low heat, such as when melting chocolate or holding sauces. Use cookware appropriate in size for the triple-ring Element.

WARMING ZONE ELEMENT

- Use the Warming Zone element to keep cooked foods warm. One hour is the recommended maximum time recommended to maintain food quality.
- Do not use the Warming Zone element to heat cold foods.
- The Warming Zone element can be used alone or when any of the other surface cooking areas are being used.
- The Warming Zone element area will not glow red when cycling on. However, the hot surface indicator will glow while the Warming Zone element is in use.
- Use only cookware recommended for cooktop use.
- Cover all foods with a lid or aluminum foil. When warming baked goods allow a small opening in the cover for moisture to escape.
- Do not use plastic wrap to cover food because the plastic wrap may melt.
- Use pot holders to remove food.

⚠ WARNING

Food Poisoning Hazard

Do not let food sit in oven more than one hour before or after cooking. Doing so can result in food poisoning or sickness.

RECOMMENDED HEATING ELEMENT SETTINGS

Heating elements do not require preheating. A range of heating settings is listed in the following chart because the required temperature depends on:

- Type and quality of pan
- Type, quantity and temperature of the food
- Element used and cook's preferences

TYPE OF FOOD	HEAT SETTINGS RADIANT ELEMENTS
	Energy regulator
Melt butter, chocolate	LO
Rice, Simmer sauces with butter and egg yolk	LO to Medium
Cook vegetables, fish broths, cereals, pasta, milk, pan-cakes, pudding; Scramble egg; Simmer meat; Steam vegetables; Made pop-corn, bacon; Stew meat soup; Saute vegetables, spaghetti sauces.	Medium
Braise/Fry/Saute/Quickly Boil meat, fish, egg.	Medium to HI
Boil water for vegetables, pasta	HI

CONTROL KNOBS

The control knobs turn in either direction and from any position to the desired temperature setting or to OFF.

NOTE: Once the element is turned Off, the Hot Surface indicator light will remain illuminated until the surface temperature of the element has cooled. The placement of each knob corresponds to the placement of the heating element that it controls.

To Turn On Any Heating Element: PUSH DOWN on the knob and TURN in either direction to desired heat setting.

⚠ WARNING



Fire Hazard

Turn off all controls when done cooking. Failure to do so can result in death or fire.

COOKWARE

The choice of pan directly affects the cooking performance(speed and uniformity). For best results, select pans with the following features.

Flat Base: Use flat-bottomed cookware for best heat conduction and energy efficiently. Cookware with rounded, warped, ribbed or dented bottoms could cause uneven heating and poor cooking.

- Determine flatness by placing the straight edge of a ruler across the bottom of the cookware. While you rotate the ruler, no space or light should be visible between it and the cookware.
- Cookware designed with slightly indented bottoms or small expansion channels can be used.

Match Pan Diameter to Element:



COOKWARE CHARACTERISTICS

- **Aluminum:** Heat and cool quickly. It can be used for frying, braising and roasting, but may leave metal marks on the glass.
- **Cast iron:** Heat and cool slowly, but it retain heat and cook evenly.
- **Copper:** Heat and cool quickly. Best for gourmet cooking, wine, sauce, egg dishes.
- **Enamel ware:** The reaction depends on the base metal. Not recommended. Flaws in the enamel may scratch the cooktop.
- **Glass ceramics:** Heat and cool slowly,. Not recommended. The heat is too slow. Flaws may scratch the cooktop.
- **Stainless steel:** Heat and cool quickly. Suitable for soups, sauces, vegetables and general cook.

HOME CANNING

⚠ WARNING

Food Poisoning Hazard

Safe canning requires that harmful micro organisms are destroyed and that the jars are sealed completely. When canning foods in a water-bath canner, a gentle but steady boil must be maintained for the required time. When canning foods in a pressure canner, the pressure must be maintained for the required time. After you have adjusted the controls, it is very important to make sure the prescribed boil or pressure levels are maintained for the required time.

Failure to do so can result in food poisoning or sickness.

Canning can be performed on a glass smooth top cooking surface or traditional coil element cooktop.

- When canning for long periods, alternate the use of surface cooking areas or elements between batches. This allows time for the most recently used areas to cool.
 - Center the canner on the largest surface cooking area or element. On electric cooktops, canners should not extend more than ½" (1.3 cm) beyond the surface cooking area or element.
 - Do not place canner on 2 surface cooking areas or elements at the same time.
 - On ceramic glass models, use only flat-bottomed canners to avoid damage to the cooktop and elements.
- For more information, contact your local agricultural extension office, or refer to published home canning guides. Companies that manufacture home canning products can.

USING THE OVEN

This multi-function oven combines the functions of traditional oven modes with the functions of modern, fan-assisted convection modes in a single oven. Use the Cooking Mode control, located on the control panel, to select the oven mode.

IMPORTANT: During any cycle, the heating elements will turn off when the oven door is opened, and stay off until the door is closed. To maintain oven temperature, the door is limited during cooking.

BEFORE USE

- 1). Close the oven door.
- 2). Press Bake.
- 3). Press 500°F (260°C) on the number keypad.
- 4). Press Start.

NOTE: Allow the oven to operate for 30 minutes with the door closed and no food in the cavity.

- 5). Turn off the oven, and then open the oven door to allow the oven to cool.
- NOTE: Any odor that may be detected during this initial use is due to the evaporation of substances used to protect the oven during storage.

GENERAL

IMPORTANT: Do not place anything, including dishes, foil and oven trays, on the bottom of the oven when in operation to avoid damaging the enamel.

- 1). Place bakeware with food on one or both of the shelves provided.
- 2). Close the oven door.

NOTE: The oven cannot be set with the door open.

- 3). Press the desired oven mode ie. "BAKE".
- 4). Set the oven to the desired temperature.
- 5). Press "START".

OVEN RACKS

The oven racks can be placed in any of the height positions in oven. Oven racks have a stop to keep them from being unintentionally withdrawn fully.

MEAT THERMOMETER

Use a meat thermometer to determine whether meat, poultry and fish are

cooked to the desired degree of doneness. The internal temperature, not appearance, should be used to determine doneness.

Insert the meat thermometer probe (provided) into the socket on the left-hand side of the oven liner.

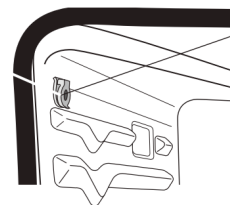

Meat Thermometer Probe Socket

PREHEATING

When beginning a Bake, Convection Bake or Convection Roast cycle, the oven will begin preheating after Start

pressed. The oven will take approximately 12 to 15 minutes to reach 350°F (177°C) with all of the oven racks provided with your oven inside the oven cavity. Higher temperatures will take longer to preheat. The pre-heat cycle rapidly increases the oven temperature. The actual oven temperature will go above your set temperature to offset the heat lost when you open the oven door to place the food on the rack. This ensures that cooking will begin at the proper temperature. Do not open the door while the oven is preheating. When the oven has heated to the set temperature, a tone will sound. You can then open the door and place food in the oven.

OVEN MODES

BAKE

Baking is cooking with heated air. Both upper and lower elements in the oven are used to heat the air but no fan is used to circulate the heat. Follow the recipe or convenience food directions for baking temperature, time and rack position. Baking time will vary with the temperature of ingredients and the size, shape and finish of the baking utensil. The temperature can be set from 170°F (77°C) to 500°F (260°C).

General Guidelines

- For best results, bake food on a single rack with at least 1" - 11/2" (2.5 - 4 cm) space between bakeware and oven walls.

- Use one rack when selecting the bake mode.
- Check for doneness at the minimum time.
- Use metal bake ware (with or without a non stick finish), heatproof glass, glass ceramic, pottery or other utensils suitable for the oven.
- When using heatproof glass, reduce temperature by 25°F (15°C) from recommended temperature.
- Use baking sheets with or without sides or jelly roll pans.
- Dark metal pans or nonstick coatings will cook faster with more browning. Insulated bake ware will slightly lengthen the cooking time for most foods.
- Do not use aluminum foil or disposable aluminum trays to line any part of the oven. Foil is an excellent heat insulator and heat will be trapped beneath it. This will alter the cooking performance and can damage the finish of the oven.
- Avoid using the opened door as a shelf to place pans.
- See Troubleshooting for tips to Solving Baking and Roasting Problems.

Bake Chart

FOOD ITEM	RACK POSITION	TEMP. °F (°C) (PREHEATED OVEN)	TIME (MIN)
Cake			
Cupcakes	2	350 (175)	19-22
Bundt Cake	1	350 (175)	40-45
Angel Food	1	350 (175)	35-39
Pie			
2 crust, fresh, 9"	2	375-400 (190-205)	45-50
2 crust, frozen fruit, 9"	2	375 (190)	68-78
Cookies			
Sugar	2	350-375 (175-190)	8-10
Chocolate Chip	2	350-375 (175-190)	8-13
Brownies	2	350 (175)	29-36
Breads			
Yeast bread loaf, 9x5	2	375 (190)	18-22
Yeast rolls	2	375-400 (190-205)	12-15
Biscuits	2	375-400 (190-205)	7-9
Muffins	2	425 (220)	15-19
Pizza			
Frozen	2	400-450 (205-235)	23-26
Fresh	2	475 (246)	15-18

To Bake

1. Close the oven door.

NOTE: The oven controls cannot be set if the oven door is open.

2. Press **BAKE**. "BAKE" will appear in the display, and 350°F (177°C) will be displayed.

"Set temp or Press **START**" will appear in the text area.

3. Press **START**, if you wish to bake at 350°F (177°C). OR Enter the desired temperature by pressing the number keypad, and then press **START**. The temperature can be set from 170°F (77°C) to 500°F (260°C).

NOTES:

- The temperature may be changed at any time during cooking. Press **CANCEL** to clear the settings. Select oven mode, then enter the desired temperature by pressing the number keypad, and then press **START**.
- After selecting an Oven Mode and Temperature, you have the option to set a Cook Time and Start Time before pressing **START**. See "Cook Time" and "Start Time."

4. Once **START** has been pressed, the oven will begin to preheat. When the oven has reached the set temperature, a tone will sound.

NOTE: If a Start Time was set, the oven will turn on at the set time.

5. Place the food in the oven and close the oven door when preheat is complete.

6. Press **CANCEL** when finished cooking, and remove food from the oven.

NOTE: If you used Cook Time or Start Time to set a cook time, the oven will turn off automatically.

BROIL

"Broil" uses direct radiant heat to cook food. The lower the temperature, the slower the cooking. Thicker cuts and unevenly shaped pieces of meat, fish and poultry may cook better at lower broiling temperatures.

NOTES:

- Before broiling, position rack according to the Broiling Chart.
- For best results, use a two-piece broiler pan with a grid (not provided). It is designed to drain juices which helps to avoid spatter and smoke.
- For proper draining, do not cover the grid with foil. The bottom of the pan may be lined with aluminum foil for easier cleaning.
- Trim excess fat to reduce spattering. Slit the remaining fat on the edges to avoid curling.

- Select HI Broil 550°F (288°C) for most broiling. Select LO Broil 450°F (232°C) for low-temperature broiling for foods that take longer to cook, such as poultry, to avoid over browning.
- Pull out oven rack to stop position before turning or removing food. Use tongs to turn food to avoid the loss of juices. Very thin cuts of fish, poultry or meat may not need to be turned.
- After broiling, remove the pan from the oven when removing the food. Drippings will bake on the pan if left in the heated oven, making cleaning more difficult.
- Position food on grid in the broiler pan, then place it in the center of the oven rack. Close the oven door and set the control.

To Broil

The temperature can be set from 450°F (232°C) to 550°F (288°C).

- 1). Place the food in the oven, preheating is not necessary.
- 2). Close the oven door.
- 3). Press BROIL. “BROIL” and “Set temp or START” and “550°F” (288°C) will be displayed.
- 4). Press START, if you wish to broil at 550°F (288°C). OR Enter the desired temperature by pressing the number keypad, and then press START. The temperature can be set from 450°F (232°C) to 550°F (288°C).

NOTES:

- The temperature can be changed at any time during cooking. Press CANCEL to clear the settings. Select oven mode, then enter the desired temperature by pressing the number keypad, and then press START.
- After selecting an Oven Mode and Temperature, you have the option to set a Cook Time and Start Time before pressing START. See “Cook Time” and “Start Time.”
- 5). BROIL will appear in the display after Start is pressed.
- 6). When cooking is finished, press CANCEL, and then remove food from the oven.

NOTE: If you used Cook Time or Delay Start to set a cook time, the oven will turn off automatically.

WARM/PROOF

The Warm mode keeps hot, cooked foods at serving temperature. The Proof mode prepares dough for baking by activating the yeast. Follow

the recipe directions as a guide.

⚠ WARNING

Food Poisoning Hazard

Do not let food sit in oven more than one hour before or after cooking. Doing so can result in food poisoning or sickness.

IMPORTANT: Food must be at serving temperature before placing it in the warmed oven. Food may be held up to 1 hour; however, breads and casseroles may become too dry if left in the oven during the Warm function. For best results, cover food.

Warm

- 1). Press WARM/PROOF, and then press WARM on the menu screen. “WARM” and “Set Temp or Press START” and 170°F (78°C) will be displayed.
 - 2). Press START, if you wish to Warm food at 170°F (78°C). OR Enter the desired temperature by pressing the number keypad, and then press START. The temperature can be set from 140°F (60°C) to 210°F (99°C).
 - 3). “WARM” will appear in the display, once Start is pressed.
- NOTE:** After selecting an Oven Mode and Temperature, you have the option to set a Cook Time and Start Time before pressing START. See “Cook Time” and “Start Time.”
- 4). Place food in the oven and close the door.
 - 5). Press CANCEL when finished, and remove food from the oven.

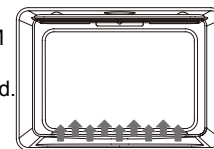

Proof

Before proofing, place the dough in a lightly greased bowl and cover loosely with wax paper, coated with shortening.

- 1). Place on second rack from the bottom and close the oven door.
2. Press WARM/PROOF, and then press PROOF on the menu screen. “PROOF” and “Set Temp or Press START,” and 100°F (38°C) will be displayed.

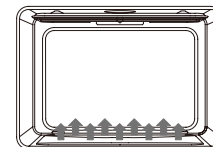

3). Press START, if you wish to Proof dough at 100°F (38°C). OR Enter the desired temperature by pressing the number keypad, and then press START. The temperature can be set from 80°F (27°C) to 120°F (49°C).

4). "PROOF" will appear in the display, once Start is pressed.

NOTE: After selecting an Oven Mode and Temperature, you have the option to set a Cook Time and Start Time before pressing START. See "Cook Time" and "Start Time."

5). Let the dough rise until nearly doubled in size, checking after 20-25 minutes. Proofing time may vary depending on dough type and quantity.

6). Press CANCEL when finished.

7). Before second proofing, shape the dough, place it in baking pan(s) and cover loosely with plastic wrap, coated with cooking spray. Follow the same placement and control steps above. Before baking, remove the plastic wrap.

CONVECTION MODES

During convection cooking, the fan provides hot air circulation throughout the oven. The movement of heated air around the food can help to speed up cooking by penetrating the cooler outer surfaces. Food cooks more evenly, browning and crisping outer surfaces while sealing moisture inside. When the oven is set to the Convection function, the ring element, bake and broil elements, and the fan operate to heat the oven cavity. If the oven door is opened during convection cooking or preheating, the fan turns off immediately and the element(s) will turn off after 30 seconds. Once the door is closed, the element(s) will automatically turn on.

CONVECTION FAN

The convection fan operates during any convection mode. When the oven is operating in convection mode, the fan will turn off automatically when the door is opened. The convection fan may run in non-convection modes during the preheat time.

CONVECTION BAKE

- Use Convection Bake for single or multiple rack baking. Reduce standard recipe baking temperature by 25°F (15°C).
- For best results, foods should be cooked uncovered, in low-sided pans to take advantage of the forced air circulation. Use shiny aluminum pans for

best results unless otherwise specified.

- Heatproof glass or ceramic can be used. Reduce temperature by another 25°F (15°C) when using heatproof glass dishes for a total reduction of 50°F (30°C).
- Dark metal pans may be used. Note that food may brown faster in dark metal bakeware.
- The number of racks used is determined by the height of the food to be cooked.
- Baked items, for the most part, cook extremely well in convection. Don't try to convert recipes such as custards, quiches, pumpkin pie, or cheesecakes, which do not benefit from the convection-heating process. Use the regular Bake mode for these foods.
- Multiple rack cooking for oven meals is done on rack positions 1, 2, 3, 4 and 5. All five positions can be used for cookies, biscuits and appetizers.
 - 2 Rack baking: Use positions 1 and 3.
 - 3 rack baking: Use positions 2, 3 and 4 or 1, 3 and 5.

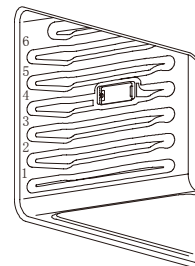

- When baking four cake layers at the same time, stagger pans so that one pan is not directly above another. For best results, place cakes on front of upper rack and back of lower rack. Allow 1" - 1 1/2" (2.5 - 4 cm) air space around pans.

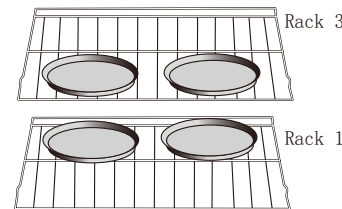

FOODS RECOMMENDED FOR CONVECTION BAKE MODE.

- Appetizers
- Biscuits
- Coffee Cakes
- Cookies (2 to 4 racks)
- Yeast Breads
- Cream Puffs
- Popovers
- Casseroles and One-Dish Entrees
- Oven Meals (rack positions 1, 2, 3)
- Air Leavened Foods (Soufflés, Meringue, Meringue-Topped Desserts, Angel Food Cakes, Chiffon Cakes)

Recommended Settings

	RACK POSITION	TEMP. °F (°C) (PREHEATED OVEN)	TIME (MIN)
Cake			
Cupcakes	2	350 (175)	19-22
Bundt Cake	1	350 (175)	40-45
Angel Food	1	350 (175)	35-39
Pie			
2 crust, fresh, 9"	2	375-400 (190-205)	45-50
2 crust, frozen fruit, 9"	2	375 (190)	68-78
Cookies			
Sugar	2	350-375 (175-190)	8-10
Chocolate Chip	2	350-375 (175-190)	8-13
Brownies	2	350 (175)	29-36
Breads			
Yeast bread loaf, 9x5	2	375 (190)	18-22
Yeast rolls	2	375-400 (190-205)	12-15
Biscuits	2	375-400 (190-205)	7-9
Muffins	2	425 (220)	15-19
Pizza			
Frozen	2	400-450 (205-235)	23-26
Fresh	2	475 (246)	15-18

To Set Convection Bake:

- 1). Press Convection BAKE once. "Set Temp or Press START" and 325°F (162°C) will be displayed.
- 2). Press START If you wish to convection bake at 325°F (162°C). OR Enter the desired temperature by pressing the number keypad, and then press START. The temperature can be set from 170°F (77°C) to 500°F(260°C).

NOTES:

- To change the set temperature press CANCEL. Press the number keypad to enter the desired temperature, and then press START.
 - After selecting an Oven Mode and Temperature, you have the option to set a Cook Time and Start Time before pressing START. See "Cook Time" and "Start Time."
- 3). The oven will begin preheating once Start is pressed. A tone will sound when the oven is at the set temperature.

NOTE: There are two preheat modes for Convection Bake. Use Rapid Preheating when using multiple racks. It is possible to switch between

"Rapid Preheating" and "Preheating" by pressing START during the preheating.

- 4). Place the food in the oven and close the oven door when preheat is completed.
- 5). Press CANCEL when finished, and then remove food from the oven.

NOTE: If you used Cook Time or Start Time to set a cook time, the oven will turn off automatically.

CONVECTION BROIL

General Guidelines

- Place rack in the required position needed before turning on the oven.
- Use Convection Broil mode with the oven door closed.
- When convection broiling, enter your normal broiling temperature.
- Do not preheat oven.
- Use the 2-piece broil pan.
- Turn meats once halfway through the cooking time. See the Convection Broil chart.
- Thicker cuts and unevenly shaped pieces of meat, fish and poultry may cook better at lower broiling temperatures.

FOOD AND THICKNESS	RACK POSITION	BROIL SETTING	INTERNAL TEMP. °F (°C)	TIME SIDE 1 (MIN.) [†]	TIME SIDE 2 (MIN.) [‡]
Beef					
Steak (1½" or more)					
Medium rare	4	Low	145 (65)	9-12	8-10
Medium	4	Low	160 (71)	11-13	10-12
Well	4	Low	170 (77)	18-20	16-17
Hamburgers (more than 1")					
Medium	4	High	160 (71)	8-11	5-7
Well	4	High	170 (77)	11-13	8-10
Poultry					
Chicken Quarters	4	Low	180 (82)	16-18	10-13
Chicken Halves	3	Low	180 (82)	25-27	15-18
Chicken Breasts	4	Low	170 (77)	13-15	9-13
Pork					
Pork Chops (1¼" or more)	4	Low	160 (71)	12-14	11-13
Sausage - fresh	4	Low	160 (71)	4-6	3-5

To Set Convection Broil:

- 1). Place the food in the oven and close the oven door.
- 2). Press Convection BROIL once. "Set Temp or Press Start" and 450°F (232°C) will be displayed.
- 3). Press START, if you wish to broil at 450°F (232°C). OR Enter the desired temperature by pressing the number keypad, and then press START. The temperature can be set from 170°F (77°C) to 550°F (288°C).

NOTES:

- To change the set temperature press CANCEL. Press the number keypad to enter the desired temperature, and then press START.
- After selecting an Oven Mode and Temperature, you have the option to set a Cook Time and Start Time before pressing START. See "Cook Time" and "Start Time."
- 4). "Convect Broil" will be displayed, once Start is pressed.
- 5). Press CANCEL when cooking is finished, and then remove food from the oven.

CONVECTION ROAST

When Convection roasting, enter your normal roasting temperature. The roasting time should be 15-30% less than in conventional cooking. It is not necessary to preheat the oven for convection roast.

General Guidelines

- Do not preheat for Convection Roast.
- Roast in a low-sided, uncovered pan.
- When roasting whole chickens or turkey, tuck wings behind back and loosely tie legs with kitchen string.
- Use the 2-piece broil pan for roasting uncovered.
- Use the probe or a meat thermometer to determine the internal doneness.
- Double-check the internal temperature of meat or poultry by inserting meat thermometer into another position.
- Large poultry may need to be covered with foil (and pan roasted) during a portion of the roasting time to prevent over-browning.
- The minimum safe temperature for stuffing in poultry is 165°F (75°C).
- After removing the food from the oven, cover loosely with foil for 10 to 15 minutes before carving if necessary to increase the final foodstuff temperature by 5° to 10°F (3° to 6° C).

MEATS	WEIGHT (lb)	OVEN TEMP. °F (°C)	RACK POSITION	TIME (min. per lb)	INTERNAL TEMP. °F (°C)
Beef					
Rib Roast	4-6	325 (160)	2	16-20 18-22	145 (63) medium rare 160 (71) medium
Rib Eye Roast, (boneless)	4-6	325 (160)	2	16-20 18-22	145 (63) medium rare 160 (71) medium
Rump, Eye, Tip, Sirloin (boneless)	3-6	325 (160)	2	16-20 18-22	145 (63) medium rare 160 (71) medium
Tenderloin Roast	2-3	400 (205)	2	15-20	145 (63) medium rare
Pork					
Loin Roast (boneless or bone - in)	5-8	350 (175)	2	16-20	160 (71) medium
Shoulder	3-6	350 (175)	2	20-25	160 (71) medium
Poultry					
Chicken whole	3-4	375 (190)	2	18-21	180 (82)
Turkey, not stuffed	12-15	325 (160)	1	10-14	180 (82)
Turkey, not stuffed	16-20	325 (160)	1	9-11	180 (82)
Turkey, not stuffed	21-25	325 (160)	1	6-10	180 (82)
Turkey Breast	3-8	325 (160)	1	15-20	170 (77)
Comish Hen	1-1½	350 (175)	2	45-75 total	180 (82)
Lamb					
Half Leg	3-4	325 (160)	2	22-27 28-33	160 (71) medium 170 (77) well
Whole Leg	6-8	325 (160)	1	22-27 28-33	160 (71) medium 170 (77) well

To Set Convection Roast:

- 1). Place the food in the oven and close the oven door.
- 2). Press CONVECTION ROAST once. "Set Temp or Press Start", and 325°F (163°C) will be displayed.
- 3). Press START, if you wish to convection roast at 325°F (163°C). OR Enter the desired temperature by pressing the number keypad, and then press START. The temperature can be set from 170°F (77°C) to 500°F (260°C).

NOTES:

- To change the set temperature press CANCEL. Press the number keypad to enter the desired temperature, and then press START.
 - After selecting an Oven Mode and Temperature, you have the option to set a Cook Time and Start Time before pressing START. See "Cook Time" and "Start Time."
- 4). Press START. After pressing START, the oven will display "CONVECT ROAST" while cooking.
 - 5). Press CANCEL when finished, and then remove food from the oven.

NOTE: If you used Cook Time or Start Time to set a cook time, the oven will turn off automatically.

CONVECTION CONVERSION

When using a Convection Recipe, enter your normal cooking temperature and time. The Convection Conversion mode will adjust the temperature and time for perfect cooking results.

IMPORTANT:

- The oven door must be closed before selecting a Convection Conversion oven mode.
- Setting Cook Time is required for a Convection Conversion oven mode. If Cook Time was not set, the control will prompt you to Set Cook Time. See "CookTime."

NOTE: At the end of the set Cook Time, the oven will turn off automatically, the end of cycle tone will sound and "Cooking Complete" will appear in the display.

Baked Goods

- 1). Press BAKED GOODS among the Convection Conversion controls.
- 2). Set the oven temperature.

NOTE: The temperature can be set from 170°F (77°C) to 500°F (260°C).

- 3). Press START. "Set cooking time" will appear in the display.
- 4). Press the number keypad to enter the desired cook time. Press START will appear in the display.

NOTE: If a delayed start time is desired, Press START TIME, and then press the number keypad to enter the desired start time. Press START will appear the display. Set Cook Time is mandatory for the Convection oven mode. If Cook Time was not set, the control will prompt you to "Set Cook Time."

- 5). Press START. The oven begins to preheat. Once the set temperature has been reached, a tone will sound.

NOTE: If the recipe requires the food to be cooked in a preheated oven, add 15 minutes to Cook Time to allow time for the oven to preheat. Once the oven is heated to the set temperature and the tone sounds, place food in the oven.

- 6). At the end of the set Cook Time the oven will turn off automatically, the end of cycle tone will sound and "Cooking Complete" will appear in the display.

Meats

IMPORTANT: It is not necessary to preheat the oven for the convection conversion MEAT option.

- 1). Press MEATS among the Convection Conversion controls.
- 2). Set the oven temperature.

NOTE: The temperature can be set from 170°F (77°C) to 500°F (260°C).

- 3). Press START. "Set cooking time" will appear in the display.
- 4). Press the number keypad to enter the desired cook time. "Press START" will appear in the display.

NOTE: Set Cooking Time is mandatory for the Convection Conversion oven mode.

- 5). At the end of the set Cook Time the oven will turn off automatically, the end of cycle tone will sound and "Cooking Complete" will appear in the display.

Other Foods

- 1). Press OTHER FOODS among the Convection Conversion controls.
- 2). Set the oven temperature.

NOTE: The temperature can be set from 170°F (77°C) to 500°F (260°C).

- 3). Press START. "Set cooking time" will appear in the display.
- 4). Press the number keypad to enter the desired cook time. Press START will appear in the display.

NOTE: If a delayed start time is desired, Press START TIME, and then press the number keypad to enter the desired start time. Press START will appear the display. Set Cook Time is mandatory for the Convection oven mode. If Cook Time was not set, the control will prompt you to "Set Cook Time."

- 5). Press START. The oven begins to preheat. Once the set temperature has been reached, a tone will sound.

NOTE: If the recipe requires the food to be cooked in a preheated oven, add 15 minutes to Cook Time to allow time for the oven to preheat. Once the oven is heated to the set temperature and the tone sounds, place food in the oven.

- 6). At the end of the set Cook Time the oven will turn off automatically, the end of cycle tone will sound and "Cooking Complete" will appear in the display.

MAINTENANCE

CLEANING

IMPORTANT: Before cleaning, make sure all controls are turned off, and the oven and cooktop are cool. Always follow label instructions on cleaning products. It is recommended that you first use soap, water and a soft cloth or sponge unless otherwise noted. Do not use abrasive cleaning products.

EXTERIOR PORCELAIN ENAMEL SURFACES

Food spills containing acids, such as vinegar and tomato, should be cleaned as soon as the entire appliance is cool. These spills may affect the finish.

Cleaning Method:

Glass cleaner, mild liquid cleaner or nonabrasive scrubbing pad: Gently clean around the model and serial number plate because scrubbing may remove numbers.

EXTERIOR STAINLESS STEEL

NOTE: Do not use soap-filled scouring pads, abrasive cleaners, cooktop polishing cream, steel-wool pads, gritty washcloths or some paper towels. Damage may occur, even with one-time or limited use.

Rub in direction of grain to avoid damaging.

Cleaning Method:

Liquid detergent or all-purpose cleaner: Rinse well with clean water and dry with soft, lint-free cloth.

Stainless Steel Cleaner and Polish

Vinegar for hard water spots

OVEN DOOR EXTERIOR

Cleaning Method:

Glass cleaner and paper towels or nonabrasive plastic scrubbing pad:

Apply glass cleaner to soft cloth or sponge, not directly on panel.

CERAMIC GLASS COOKTOP

IMPORTANT: To avoid damaging the cooktop, do not use steel wool, abrasive powder cleansers, chlorine bleach, rust remover or ammonia. Ceramic cooktop cleaning materials: cooktop cleaner, cooktop scraper and cooktop cleaning pads are available at most grocery stores.

To Clean the Ceramic Glass Cooktop:

1). Remove food/residue with a cooktop scraper.

- For best results, use the cooktop scraper while the cooktop is still warm,

but not hot to the touch.

- It is recommended to wear an oven mitt while scraping the warm cooktop.
- Hold the cooktop scraper at approximately a 45° angle against the glass surface and scrape the residue. It will be necessary to apply pressure in order to remove the residue.
- Allow the cooktop to cool down completely before proceeding to Step 2.

2). Apply a few dime-sized drops of cooktop cleaner to the affected areas.

- Rub cooktop cleaner onto the cooktop surface with a nylon or similar cooktop cleaning pad. Some pressure is needed to remove stubborn stains.
- Allow the cleaner to dry to a white haze before proceeding to Step 3.

3). Polish with a clean, dry cloth or a clean, dry paper towel.

SMUDGES FROM ALUMINUM BOTTOMED PANS

Cleaning Method:

A cloth dampened in vinegar.

COOKTOP CONTROL KNOBS

- Pull knobs straight out from the control panel to remove.
- When replacing knobs, make sure knobs are turned to the Off position.

Cleaning Method:

Soap and water or dishwasher:

NOTE: Do not use steel wool, abrasive cleansers or oven cleaner. Do not soak knobs.

CONTROL PANEL

Cleaning Method:

Glass cleaner and soft cloth or sponge: Apply glass cleaner to soft cloth or sponge, not directly on panel.

NOTE: Do not use abrasive cleaners, steel-wool pads, gritty washcloths or some paper towels. Damage may occur.

OVEN CAVITY

Food spills should be cleaned when oven cools. At high temperatures, foods react with porcelain, so staining, etching, pitting or faint white spots can result.

Cleaning Method:

Mild detergent and warm water.

NOTE: Do not use oven cleaners.

OVEN RACKS

Cleaning Method:

Steel-wool pad

OVEN SELF-CLEANING



The Self-Cleaning cycle uses very high temperatures, burning soil to a powdery ash.

IMPORTANT: The health of some birds is extremely sensitive to the fumes given off during the Self-Cleaning cycle. Exposure to the fumes may result in death to certain birds. Always move birds to another closed and well-ventilated room.

NOTES:

- Self-clean the oven before it becomes heavily soiled. Heavy soil results in longer cleaning and more smoke.
- Keep the kitchen well-ventilated during the Self-Cleaning cycle to help get rid of heat, odors, and smoke.
- Do not clean, rub, damage or move the oven gasket. The door gasket is essential for a good seal.
- Allow the oven to cool to room temperature before using the Self-Clean feature. If your oven cavity is above 170°F (77°C), “Oven Cooling” will appear in the display and the Self-Clean cycle will not activate until it cools down.
- The oven light will not work during the Self-Cleaning cycle. On some models, the surface elements will not work during the Self-Cleaning cycle.

• When “LOCK” shows in the display, the oven door cannot be opened. To avoid damage to the door, do not force the door open when “LOCK” is displayed.

Prepare Oven:

- Remove the broiler pan, cookware and bakeware and, on some models, the temperature probe from the oven.
- Remove oven racks to keep them shiny and easy to slide. See “General Cleaning” section for more information.
- Remove any foil from the oven because it may burn or melt, damaging the oven.
- Hand clean inside door edge and the 1½" (3.8 cm) area around the inside oven cavity frame, being certain not to move or bend the gasket. This area does not get hot enough during self-cleaning to remove soil. Do not let water, cleaner, etc., enter slots on door frame. Use a damp cloth to clean this area.
- Wipe out any loose soil to reduce smoke and avoid damage. At high temperatures, foods react with porcelain. Staining, etching, pitting or faint white spots can result. This will not affect cooking performance.

To Self-Clean:

NOTE: The oven is preset for a 2.5 hour Cleaning cycle; however, the Cleaning time can be adjusted. Suggested cleaning times are:

- 2 Hours - Light soil
- 3 Hours - Average soil
- 3.5 Hours - Heavy soil.

1). Close the oven door.

NOTE: If an oven door is left open, “Door Open Clean Canceled” will appear in the display and a tone will sound.

2). Press SELF CLEAN. “Remove Racks” will scroll in the selected oven text area for 5 seconds, followed by “Select Option.”

“Select Level” and “Press 1. Level 1 (Quick) 2. Level 2, 3. Level 3, 4.

Level 4 (reg), 5. Level 5, 6. Level 6 (Maxi)” will scroll in the display text area.

3). Enter the desired Clean level by pressing the number keypad, and then press START.

NOTE: The oven door will lock. “SELF CLEAN” will scroll in the display panel until the clean cycle is finished.

When the self-clean cycle ends:

“COMPLETE” appears in the display and the oven door unlocks

4). Open the oven door. Once the oven has completely cooled, remove ash with a damp cloth.

NOTE: Set Cooking Time is mandatory for the Convection Conversion oven mode.

To Delay Start Self-Clean:

- 1). Press START TIME.
- 2). "--:--" will be displayed, and "Set time to delay. Then Press START" will scroll from right to left in the selected oven text area. Enter the time-of-day that you want oven cleaning to begin, by pressing the number keypad.
- 3). Press START. "Select cooking/cleaning mode" will scroll in the selected oven text area.
- 4). Press SELF CLEAN. "Remove Racks" will scroll in the selected oven text area for 5 seconds, followed by "Select Option."
- 5). "Select Level" and "Press 1. Level 1 (Quick) 2. Level 2, 3. Level 3, 4. Level 4 (reg), 5. Level 5, 6. Level 6 (Maxi)" will scroll in the display text area.
- 6). Enter the desired Clean level by pressing the corresponding number on the keypad.
- 7). Press START. The cleaning cycle will begin when the set Time is reached.

When the self-clean cycle ends:

"COMPLETE" appears in the display and the oven door unlocks.

- 8). Open the oven door. Once the oven has completely cooled, remove ash with a damp cloth.

NOTE: To avoid breaking the glass, do not apply a cool, damp cloth to the inner door glass before it has completely cooled.

OVEN DOOR REMOVAL

For normal oven use, there is no need to remove the oven door. If necessary to remove the door, follow the instructions in this section.

IMPORTANT:

- Make sure oven is cool and power to the oven has been turned off before removing the door.
- The oven door is heavy and fragile, and the door front is glass. To avoid oven door glass breakage, use both hands, and grasp only the sides of the oven door to remove.
- Be sure that both levers are securely in place before removing the door.
- Do not force door open or closed.

To Remove the Oven Door:

- 1). Open the oven door completely.

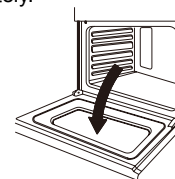

- 2). Lift up the hinge latch on each side.

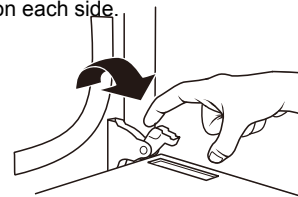

- 3). Close the oven door as far as it will shut.
- 4). While grasping both outside edges of the oven door, lift up on the door.
- 5). Continue to push the top of the door closed, while pulling the bottom of the door out of the hinge receivers in the door frame.



To Replace the Oven Door:

- 1). Insert both hanger arms into the hinge receivers in the door frame.
- 2). Slowly open the oven door, and you will feel the door set into place.
- 3). Move the hinge latches back into the locked position.
- 4). Check that the door opens and closes freely. If it does not, repeat the door removal and replacement procedures..

REPLACING AN OVEN LIGHT

⚠ WARNING



Electrical Shock Hazard

Make sure the oven and lights are cool and power to the oven has been turned off before replacing the light bulb(s).

The lenses must be in place when using the oven. The lenses serve to protect the light bulb from breaking.

The lenses are made of glass. Handle carefully to avoid breakage. Failure to do so could result in death, electric shock, cuts or burns.

The oven light is a standard 25 watt (G9) appliance bulb.

IMPORTANT: Before replacing the bulb, make sure the oven is cool and the controls are turned off.

- 1). Disconnect power at the main power supply (fuse or breaker box).
- 2). Remove the bulb cover by pulling it out of the opening.

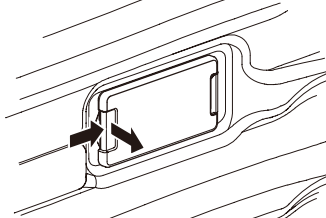

3. Remove the burned out bulb from the socket.

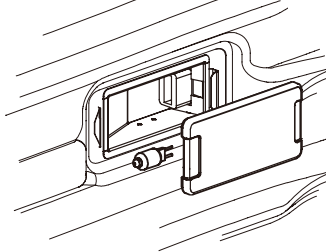

NOTE: To avoid damage or decreasing the life of the new bulb, do not touch bulb with bare fingers. Wear cotton gloves or use a tissue when replacing the light bulb.

- 4). Replace the bulb, and then replace the bulb cover.
- 5). Reconnect power at the main power supply (fuse or breaker box).

TROUBLESHOOTING

BAKING AND ROASTING PROBLEMS

With any oven setting poor results can occur for many reasons other than a malfunction of the oven. Check the chart below for causes of the most common problems. Since the size, shape and material of baking utensils directly affect the baking results, the best solution may be to replace old baking utensils that have darkened and warped with age and use.

BAKING PROBLEM	CAUSE
Food browns unevenly	<ul style="list-style-type: none"> Oven not preheated Aluminum foil on oven rack or oven bottom Baking utensil too large for recipe Pans touching each other or oven walls
Food too brown on bottom	<ul style="list-style-type: none"> Oven not preheated Using glass, dull or darkened metal pans Incorrect rack position Pans touching each other or oven walls
Food is dry or has shrunk excessively	<ul style="list-style-type: none"> Oven temperature too high Baking time too long Oven door opened frequently Pan size too large
Food is baking or roasting too slowly	<ul style="list-style-type: none"> Oven temperature too low Oven not preheated Oven door opened frequently Tightly sealed with aluminum foil Pan size too small
Piecrusts do not brown on bottom or crust is soggy	<ul style="list-style-type: none"> Baking time not long enough Using shiny steel pans Incorrect rack position Oven temperature is too low
Cakes pale, flat and may not be done inside	<ul style="list-style-type: none"> Oven temperature too low Incorrect baking time Cake tested too soon Oven door opened too often Pan size may be too large

Cakes high in middle with crack on top	<ul style="list-style-type: none"> Oven temperature too high Baking time too long Pans touching each other or oven walls Incorrect rack position Pan size too small
Piecrust edges too brown	<ul style="list-style-type: none"> Oven temperature too high Edges of crust too thin

COOKTOP

PROBLEM	POSSIBLE CAUSE	SOLUTION
Heating elements and controls do not work.	<ul style="list-style-type: none"> Fuse is blown or circuit breaker is tripped. No electricity to the cooktop. 	<ul style="list-style-type: none"> Replace the fuse or reset the circuit breaker. If the problem continues, call an electrician. Have electrician check your power supply.
Heating elements do not heat properly.	<ul style="list-style-type: none"> Improper cookware is being used. 	<ul style="list-style-type: none"> Select proper cookware. See "Cookware." If the problem continues, call for service.
Heating elements cycle off even when elements are turned to their highest settings.	<ul style="list-style-type: none"> Heating element temperature limiters are temporarily shutting off the elements due to exceeding the maximum allowable temperature. 	<ul style="list-style-type: none"> This is a normal operating condition, especially during rapid heat-up operations. The element will cycle back on automatically after it has cooled sufficiently.
Glass ceramic surface is see through or appears to be red in color.	<ul style="list-style-type: none"> Under direct or bright lighting, you will sometimes be able to see through the glass and into the chassis due to its transparent quality. You may also notice a red tint under these conditions 	<ul style="list-style-type: none"> These are normal properties of black ceramic glass panels.

OVEN

PROBLEM	POSSIBLE CAUSE	SOLUTION
Oven is not heating	No power to the oven	Replace the fuse or reset the circuit breaker. If the problem continues, call an electrician.
	Oven control not turned on	Make sure the oven temperature has been selected.
	Oven door is not closed.	Close the oven door. The heating elements turn off when the door is opened and remain off until the oven door is closed.
Oven is not cooking evenly	Not using the correct bake ware or oven rack position	Refer to cook charts for recommended rack position. Always reduce recipe temperature by 25 °F (15 °C) when baking with Convention Bake mode.
Oven display stays off	Power interruption	Turn off power at the main power supply (fuse or breaker box). Turn breaker back on. If condition persists, call for service.
Oven mode and temperature controls cannot be set.	The oven door is open.	Close the oven door. The oven mode and temperature controls cannot be set if the oven door is open.
Cooling fan continues to run after oven is turned off	The electronic components have not yet cooled sufficiently	The fan will turn off automatically when the electronic components have cooled sufficiently.
Oven light is not working properly	Light bulb loose or burned-out.	Reinsert or replace the light bulb. Touching the bulb with fingers may cause the bulb to burn out.
Oven light stays on	Door is not closing completely	Check for obstruction in oven door. Check to see if hinge is bent or door switch broken.
Cannot remove lens cover	Soil build-up around the lens cover.	Wipe lens cover area with a clean, dry towel prior to attempting to remove the lens cover.
Clock and timer are not working properly	No power to the oven	Check the circuit breaker or fuse box to your house. Make sure there is proper electrical power to the oven.

Excessive Moisture		When using bake mode, preheat the oven first. Convection Bake and Convection Roast will eliminate any moisture in the oven.
Porcelain Chips	Porcelain interior is bumped by oven racks	When removing and replacing oven racks, always tilt racks upward and do not force them to avoid chipping the porcelain.

